

Reasoning about Graded Strategy Quantifiers

Vadim Malvone^a, Fabio Mogavero^b, Aniello Murano^{a,*}, Loredana Sorrentino^a

^a*Università di Napoli Federico II, Department DIETI, Via Claudio, n.21, 80125, Napoli, Italy.*

^b*University of Oxford, Department of Computer Science, Wolfson Building, Parks Road
Oxford, OX1 3QD, U.K.*

Abstract

In this paper we introduce and study *Graded Strategy Logic* (GSL), an extension of *Strategy Logic* (SL) with *graded quantifiers*. SL is a powerful formalism that allows to describe useful game concepts in multi-agent settings by explicitly quantifying over strategies treated as first-order citizens. In GSL, by means of the existential construct $\langle\langle x \geq g \rangle\rangle\varphi$, one can enforce that there exist at least g strategies x satisfying φ . Dually, via the universal construct $\llbracket x < g \rrbracket\varphi$, one can ensure that all but less than g strategies x satisfy φ .

Strategies in GSL are counted semantically. This means that strategies inducing the same outcome, even though looking different, are counted as one. While this interpretation is natural, it requires a suitable machinery to allow for such a counting, as we do. Precisely, we introduce a non-trivial equivalence relation over strategy profiles based on the strategic behavior they induce.

To give an evidence of GSL usability, we investigate some basic questions about the *Vanilla* GSL[1G] fragment, that is the vanilla restriction of the well-studied *One-Goal Strategy Logic* fragment of SL augmented with graded strategy quantifiers. We show that the model-checking problem for this logic is PTIME-COMplete. We also report on some positive results about the determinacy.

Keywords: Strategic reasoning, Strategy Logic, Counting quantifiers.

1. Introduction

Formal methods in system design are a renowned story of success. Break-through contributions in this field comprise *model checking* [1, 2] and *temporal logics* such as LTL [3], CTL [1], CTL* [4], and the like. First applications of these methodologies involved *closed systems* [5] generally analyzing whether a Kripke structure, modeling the system, meets a temporal logic formula, specifying the desired behavior [6]. In the years several algorithms have been proposed in this setting and some implemented as tools [7]. Nevertheless these approaches turn to be useless when applied to *open systems* [5]. The latter are characterized,

*Corresponding author:

Email address: `murano@na.infn.it` (Aniello Murano)

in the simplest situation, by an ongoing interaction with an external environment on which the whole system behavior deeply relies. To be able to deal with the unpredictability of the environment, extensions of the basic verification techniques have come out. A first attempt worth of note is *module checking* where a Kripke structure is replaced by a specific two-player arena. Module checking has been first introduced in [8, 9]. In the last decade this methodology has been fruitfully extended in several directions (see [10, 11, 12] for some related works).

Starting from the study of module checking, researchers have looked for logics focusing on the *strategic behavior* of players in *multi-agent systems* [13]. One of the most important developments in this field is *Alternating-Time Temporal Logic* (ATL*, for short), introduced by Alur, Henzinger, and Kupferman [13]. This logic allows to reason about strategies of agents having the satisfaction of temporal goals as the payoff criterion. Formally, it is obtained as a generalization of CTL*, in which the existential E and the universal A *path quantifiers* are replaced with *strategic modalities* of the form $\langle\langle A \rangle\rangle$ and $\llbracket A \rrbracket$, where A is a set of *agents*. Strategic modalities over agent teams are used to describe cooperation and competition among them in order to achieve certain goals. In particular, these modalities express selective quantifications over those paths that are the result of infinite interaction between a coalition and its complement.

Despite its expressiveness, ATL* suffers from the strong limitation that strategies are treated only implicitly in the semantics of its modalities. This restriction makes the logic less suited to formalize several important solution concepts, such as *Nash Equilibrium*. These considerations led to the introduction of *Strategy Logic* (SL, for short) [14, 15], a more powerful formalism for strategic reasoning. As a key aspect, SL treats strategies as *first-order objects* that can be determined by means of the existential $\langle\langle x \rangle\rangle$ and universal $\llbracket x \rrbracket$ quantifiers, which can be respectively read as “*there exists a strategy x*” and “*for all strategies x*”. Remarkably, a strategy in SL is a generic conditional plan that at each step prescribes an action on the base of the history of the play. Such a plan is not intrinsically glued to a specific agent but an explicit binding operator (a, x) allows to link an agent a to the strategy associated with a variable x .

A common aspect about all logics mentioned above is that quantifications are either existential or universal. *Per contra*, there are several real scenarios in which “more precise” quantifications are crucially needed (see [16, 17], for an argumentation). This has attracted the interest of the formal verification community to *graded modalities*. These have been first studied in classic modal logic [18] and then exported to the field of *knowledge representation* to allow quantitative bounds on the set of individuals satisfying specific properties. Specifically, they are *counting quantifiers* in first-order logics [19], *number restrictions* in *description logics* [20, 21, 22, 23] and *numerical constraints* in query languages [24].

First applications of graded modalities in formal verification concern closed systems. In [25], *graded μ CALCULUS* has been introduced in order to express statements about a given number of immediately accessible worlds. Successively in [26, 27, 28, 16], the notion of graded modalities have been extended to deal with number of paths. Among the others graded CTL (GCTL, for short) has

been introduced with a suitable axiomatization of counting [16]. This work has been recently extended in [29] to address GCTL*, a graded extension of CTL*.

In open systems verification, we are aware of just two orthogonal approaches in which graded modalities have been investigated, but in a very restricted form: module checking for graded μ CALCULUS [30] and an extension of ATL with graded path modalities (GATL, for short) [31]. In particular, the former involves a counting of one-step moves among two agents, the latter allows for a more restricted counting on the histories of the game, but in a multi-player setting. Both approaches suffer of several limitations. First, not surprisingly, they cannot express powerful game reasoning due to the limitation of the underlying logic. Second, it is based on a very rigid and restricted counting of strategies.

In this paper, we take a different approach by formally introducing a machinery to count strategies in a multi-agent setting and use it upon the powerful framework of SL. Precisely, we introduce and study *Graded Strategy Logic* (GSL) which extends SL with the existential $\langle\langle x \geq g \rangle\rangle\varphi$ and universal $\llbracket x < g \rrbracket\varphi$ graded strategy quantifiers. They allow to express that there are *at least* g or *all but less than* g strategies x satisfying φ , respectively. As in SL, we use the binding operator to associate these strategies to agents.

As far as the counting of strategies is concerned, one of the main difficulties resides on the fact that some strategies, although looking different, produce the same outcome and therefore have to be counted as one. To overcome this problem while preserving a correct counting over paths for the underlining logic SL, we introduce a suitable equivalence relation over profiles based on the strategic behavior they induce. This is by its own an important contribution of this paper.

To show the applicability of GSL we investigate basic game-theoretic and verification questions over a powerful fragment of GSL. Recall that model checking is non-elementary-complete for SL and this has spurred researchers to investigate fragments of the logic for practical applications. Here, we concentrate on the *vanilla* version of the SL[1G] fragment of SL. We recall that SL[1G] was introduced in [32]. As for ATL, vanilla SL[1G] (for the first time introduced here) requires that two successive temporal operators in a formula are always interleaved by a strategy quantifier. We prove that the model-checking problem for this logic is PTIME-COMplete. We also show positive results about the determinacy of turn-based games.

GSL can have useful applications in several multi-agent game scenarios. For example, in safety-critical systems, it may be worth knowing whether a controller agent has a redundant winning strategy to play in case of some fault. Having more than a strategy may increase the chances for a success [33], *i.e.*, if a strategy fails for any reason, it is possible to apply the others.

Such a redundancy can easily be expressed in GSL by requiring that at least two different strategies exist for the achievement of the safety goal. The universal graded strategy quantifier may turn useful to grade the “security” of a system. For example, one can check whether preventing the use of at most k strategies, the remaining ones are all winning. In a network this may correspond to prevent some attacks while leaving the communication open.

Outline. The sequel of the paper is structured as follows. Section 2 introduces GSL and provides some preliminaries. Section 3 introduces, by means of axioms, the equivalence relation used to count strategies. Section 4 shows how to transform a game from concurrent to turn-based. Section 5 and Section 6 address the determinacy and the model-checking problem for Vanilla GSL[1G]. Finally we conclude in Section 7 with some discussions and future work.

2. Graded Strategy Logic

In this section we introduce syntax and semantics of *Graded Strategy Logic* (GSL, for short), an extension of *Strategy Logic* (SL, for short) [15] that allows reasoning about the number of strategies an agent may exploit in order to satisfy a given temporal goal. We recall that SL simply extends LTL with two strategy quantifiers and a binding construct used to associate an agent to a strategy.

This section is organized as follows. In Subsection 2.1, we recall the definition of concurrent game structure, used to interpret GSL and give some examples. In Subsection 2.2 we introduce the syntax of GSL, and, in Subsection 2.3, its semantics. Finally, in Subsection 2.4 we list the main results of this work.

2.1. Model

Similarly to SL, as semantic framework we use *concurrent game structures* [13], *i.e.*, a generalization of both *Kripke structures* [34] and *labeled transition systems* [35] in which the system is modeled as a game where players perform actions chosen strategically as a function on the history of the play.

Definition 2.1 (Concurrent Game Structure). *A Concurrent Game Structure (CGS, for short) is a tuple $\mathcal{G} \triangleq \langle \text{AP}, \text{Ag}, \text{Ac}, \text{St}, \text{tr}, \text{ap}, s_I \rangle$, where AP, Ag, Ac, and St are sets of atomic propositions, agents/players, actions and states, respectively, $s_I \in \text{St}$ is an initial state, and $\text{ap} : \text{St} \rightarrow 2^{\text{AP}}$ is a labeling function mapping each state to the set of atomic propositions true in that state. Let $\text{Dc} \triangleq \text{Ag} \rightarrow \text{Ac}$ be the set of decisions, *i.e.*, partial functions describing the choices of an action by some agent. Then, $\text{tr} : \text{Dc} \rightarrow (\text{St} \rightarrow \text{St})$ denotes the transition function mapping every decision $\delta \in \text{Dc}$ to a partial function $\text{tr}(\delta) \subseteq \text{St} \times \text{St}$ representing a deterministic graph over the states.*

Intuitively, a CGS can be seen as a generic *labeled transition graph* [35], where labels are possibly incomplete agent decisions, which determine the transitions to be executed at each step of a play in dependence of the choices made by the agents in the relative state. In particular, incomplete decisions allow us to represent any kind of legal move in a state, where some agents or a particular combination of actions may not be active. It is worth noting that, due to the way the transition function is defined, a CGS is in general nondeterministic. Indeed, two different but indistinguishable decisions may enable different transitions for the same state. Even more, a single decision may induce a non-functional relation. However, due to the focus of this work, we restrict to the case of

deterministic games structures, by describing later on few conditions that rule out how the transition function has to map partial decisions to transitions.

A concurrent game structure \mathcal{G} naturally induces a graph $\text{Gr}(\mathcal{G}) = \langle \text{St}, \text{Ed} \rangle$, whose vertexes are represented by the states and the edge relation $\text{Ed} \triangleq \bigcup_{\delta \in \text{Dc}} \text{tr}(\delta)$ is obtained by rubbing out all labels on the transitions. Note that there could be states where no transitions are available, *i.e.*, $\text{dom}(\text{Ed}) \subset \text{St}$. If this is the case, those states in $\text{St} \setminus \text{dom}(\text{Ed})$ are called *sink-states*. A *path* $\pi \in \text{Pth} \triangleq \{\pi \in \text{St}^\omega : \forall i \in \mathbb{N}. ((\pi)_i, (\pi)_{i+1}) \in \text{Ed}\}$ is simply an infinite path in \mathcal{G} . Similarly, the *order* $|\mathcal{G}| \triangleq |\text{Gr}(\mathcal{G})|$ (*resp.*, *size* $\|\mathcal{G}\| \triangleq \|\text{Gr}(\mathcal{G})\|$) of \mathcal{G} is the order (*resp.*, *size*) of its induced graph. As usual in the study of extensive-form games, finite paths also describe the possible evolutions of a play up to a certain point. For this reason, they are called in the game-theoretic jargon *histories*, whose corresponding set is denoted by $\text{Hst} \triangleq \{\rho \in \text{St}^* : \forall i \in [0, |\rho| - 1[. ((\rho)_i, (\rho)_{i+1}) \in \text{Ed}\}$. Moreover, by $\text{fst}(\rho) = \rho_0$ (*resp.*, $\text{fst}(\pi) = \pi_0$) we denote the first element in the history (*resp.*, path), by $\text{lst}(\rho)$ we denote the last element occurring in the history ρ and by $\rho_{\leq i}$ (*resp.*, $\pi_{\leq i}$) we denote the prefix up to the state of index i . We now introduce the sets of decisions, agents, and actions that trigger some transition in a given state $s \in \text{St}$ by means of the three functions $\text{dc} : \text{St} \rightarrow 2^{\text{Dc}}$, $\text{ag} : \text{St} \rightarrow 2^{\text{Ag}}$, and $\text{ac} : \text{St} \times \text{Ag} \rightarrow 2^{\text{Ac}}$ such that:

$$\text{dc}(s) \triangleq \{\delta \in \text{Dc} : s \in \text{dom}(\text{tr}(\delta))\};$$

$$\text{ag}(s) \triangleq \{a \in \text{Ag} : \exists \delta \in \text{dc}(s). a \in \text{dom}(\delta)\};$$

$$\text{ac}(s, a) \triangleq \{\delta(a) \in \text{Ac} : \delta \in \text{dc}(s) \wedge a \in \text{dom}(\delta)\}, \text{ for all } a \in \text{Ag}.$$

These functions can be easily lifted to the set of histories as follows: $\text{dc} : \text{Hst} \rightarrow 2^{\text{Dc}}$ with $\text{dc}(\rho) \triangleq \text{dc}(\text{fst}(\rho))$, $\text{ag} : \text{Hst} \rightarrow 2^{\text{Ag}}$ with $\text{ag}(\rho) \triangleq \text{ag}(\text{fst}(\rho))$, and $\text{ac} : \text{Hst} \times \text{Ag} \rightarrow 2^{\text{Ac}}$ with $\text{ac}(\rho, a) \triangleq \text{dc}(\text{fst}(\rho), a)$.

A decision $\delta \in \text{Dc}$ is *coherent w.r.t.* a state $s \in \text{St}$ (*s-coherent*, for short), if $\text{ag}(s) \subseteq \text{dom}(\delta)$ and $\delta(a) \in \text{ac}(s, a)$, for all $a \in \text{ag}(s)$. By $\text{Dc}(s) \subseteq \text{Dc}$, we denote the set of all *s-coherent* decisions.

A *strategy* is a partial function $\sigma \in \text{Str} \triangleq \text{Hst} \rightarrow \text{Ac}$ prescribing, whenever defined, which action has to be performed for a certain history of the current outcome. Roughly speaking, it is a generic conditional plan which specifies “*what to do*” but not “*who will do it*”. Indeed, a given strategy can be used by more than one agent at the same time. We say that σ is *coherent w.r.t.* an agent $a \in \text{Ag}$ (*a-coherent*, for short) if, in each possible evolution of the game, either a is not influential or the action that σ prescribes is available to a . Formally, for each history $\rho \in \text{Hst}$, it holds that either $a \notin \text{ag}(\rho)$ or $\rho \in \text{dom}(\sigma)$ and $\sigma(\rho) \in \text{ac}(\rho, a)$. By $\text{Str}(a) \subseteq \text{Str}$ we denote the set of *a-coherent* strategies. Moreover, $\text{Str}(A) \triangleq \bigcap_{a \in A} \text{Str}(a)$ indicates the set of strategies that are coherent with all agents in $A \subseteq \text{Ag}$.

For a state $s \in \text{St}$, we say that σ is *s-total* iff it is defined on all non-trivial histories (*i.e.*, $|\rho| > 0$) starting in s , *i.e.*, $\text{dom}(\sigma) = \{\rho \in \text{Hst} | \text{fst}(\rho) = s\}$.

A *profile* is a function $\xi \in \text{Prf} \triangleq \text{Ag} \rightarrow_a \text{Str}(a)$ specifying a unique behavior for each agent $a \in \text{Ag}$ by associating it with an *a-coherent* strategy $\xi(a) \in \text{Str}(a)$.

Given a profile ξ , to identify which action an agent $a \in \text{Ag}$ has chosen to perform on a history $\rho \in \text{Hst}$, we first extract the corresponding strategy $\xi(a)$ and then determine the action $\xi(a)(\rho)$, whenever defined. To identify, instead, the whole decision on ρ , we apply the standard flipping operator to ξ .¹ We get so a function $\hat{\xi} : \text{Hst} \rightarrow \text{Dc}$ such that $\hat{\xi}(\rho)(a) = \xi(a)(\rho)$, which maps each history to the planned decision.

A path $\pi \in \text{Pth}$ is a *play w.r.t.* a profile $\xi \in \text{Prf}$ (ξ -*play*, for short) iff, for all $i \in [0, |\pi|[$, there exists a decision $\delta \in \text{dc}((\pi)_i)$ such that $\delta \subseteq \hat{\xi}((\pi)_{\leq i})$ and $((\pi)_i, (\pi)_{i+1}) \in \text{tr}(\delta)$, *i.e.* $(\pi)_{i+1}$ is one of the successors of $(\pi)_i$ induced by the decision $\hat{\xi}((\pi)_{\leq i})$ prescribed by the profile ξ on the history $(\pi)_{\leq i}$.

CGSs describe generic mathematical structures, where the basilar game-theoretic notions of history, strategy, profile, and play can be defined. However, in several contexts, some constraints rule out how the function tr maps partial decisions to transitions between states. Here, as already observed, we require that the CGSs are deterministic. We do this by means of the following constraints:

1. there are no sink-states, *i.e.*, $\text{dc}(s) \neq \emptyset$, for all $s \in \text{St}$;
2. for all s -coherent decisions $\delta \in \text{Dc}(s)$, there exists a set of agents $A \subseteq \text{ag}(s)$ such that $\delta|_A \in \text{dc}(s)$;
3. each decision induces a partial function among states, *i.e.* $\text{tr}(\delta) \in \text{St} \rightarrow \text{St}$, for all $\delta \in \text{Dc}$;
4. there are no different but indistinguishable active decisions in a given state $s \in \text{St}$, *i.e.*, for all $\delta_1, \delta_2 \in \text{dc}(s)$ with $\delta_1 \neq \delta_2$, there exist $a \in \text{dom}(\delta_1) \cap \text{dom}(\delta_2)$ such that $\delta_1(a) \neq \delta_2(a)$.

Given a state $s \in \text{St}$, the determinism in a CGS ensures that there exists exactly one ξ -play π starting in s , *i.e.*, $\text{fst}(\pi) = s$. Such a play is called (ξ, s) -*play*. For this reason, we use the *play function* $\text{play} : \text{Prf} \times \text{St} \rightarrow \text{Pth}$ to identify, for each profile $\xi \in \text{Prf}$ and state $s \in \text{St}$, the corresponding (ξ, s) -*play* $\text{play}(\xi, s)$.

As a running example, consider the concurrent game structure \mathcal{G}_S depicted in Figure 1. It models a *scheduler system* that comprises two *processes*, P_1 and P_2 , willing to access a *shared resource*, such as a processor, and an *arbiter* A used to solve conflicts arisen under contending requests. The processes can use four actions: **i** for idle, **r** for (resource) request, **f** for free (a resource), and **a** for abandon (a pending request), all with the obvious meaning. The action **i** means that the process does not want to change the current situation in which the entire system resides. The action **r** is used to ask for the resource, when this is not yet owned, while the action **f** releases it. Finally, the action **a** is asserted by a process that, although has asked for the resource, did not obtain it and so it decides to relinquish the request. The system can reside in the states **I**, **1**, **2**, **1/2**, **2/1** and **W**. The first three are ruled by the processes, the last by all the agents, and **1/2** (resp, **2/1**) by P_1 (resp., P_2) and **A**. The idle state **I** indicates that none of the processes owns the resource, while a state $k \in \{1, 2\}$ asserts that process P_k is using it. The state **1/2** (resp. **2/1**) indicates that the

¹By $\hat{g} : (B \rightarrow (A \rightarrow C))$ we denote the operation of flipping of a function $g : (A \rightarrow (B \rightarrow C))$.

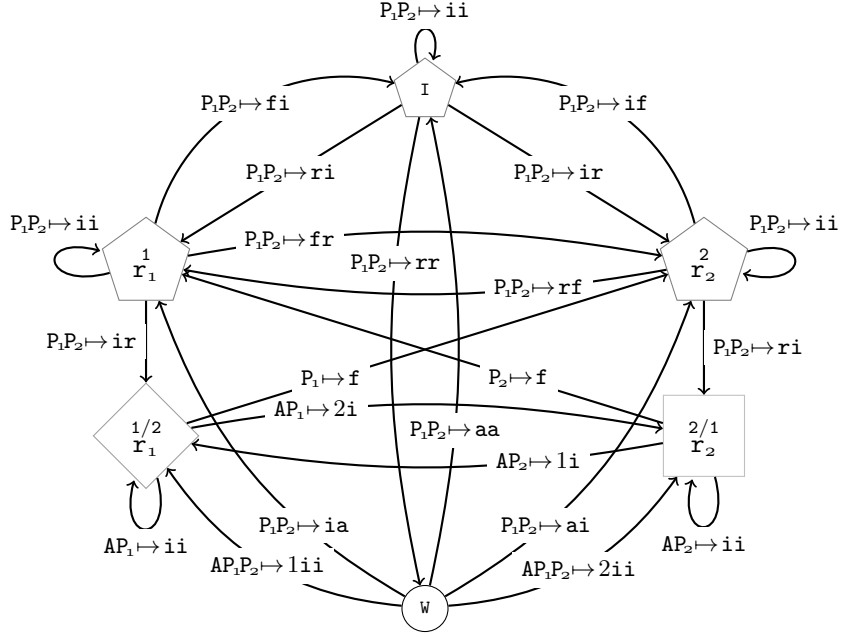

Figure 1: A scheduler system \mathcal{G}_S .

process P_1 (resp., P_2) has the resource, while its competitor requires it. Finally, the waiting state W represents the case in which an action from the arbiter is required in order to solve a conflict. To denote who is the owner of the resource, we label 1 and 1/2 (resp., 2 and 2/1) with the atomic proposition r_1 (resp., r_2). A decision is graphically represented by $\vec{a} \mapsto \vec{c}$, where \vec{a} is a sequence of agents and \vec{c} is a sequence of corresponding actions. For example $P_1 P_2 \mapsto ir$ indicates that agents P_1 and P_2 take actions i and r , respectively. All the other available decisions are depicted in Figure 1.

2.2. Syntax

GSL extends SL by replacing the two classic *strategy quantifiers* $\langle\langle x \rangle\rangle$ and $\llbracket x \rrbracket$, where x belongs to a countable set Vr of variables, with their graded version $\langle\langle x \geq g \rangle\rangle$ and $\llbracket x < g \rrbracket$, where the finite number $g \in \mathbb{N}$ denotes the corresponding *degree*, that is a bound associated to the strategy quantifiers. Intuitively, these quantifiers are read as “*there exist at least g strategies*” and “*all but less than g strategies*”. Moreover, GSL syntax comprises a set AP of atomic proposition to express properties over the states, a binding operator to link strategies to agents, and Boolean connectives.

Definition 2.2 (GSL Syntax). *GSL formulas are built inductively by means of the following context-free grammar, where $a \in Ag$, $p \in AP$, $x \in Vr$, and $g \in \mathbb{N}$:*

$$\varphi := p \mid \neg\varphi \mid \varphi \wedge \varphi \mid \varphi \vee \varphi \mid X\varphi \mid \varphi U \varphi \mid \varphi R \varphi \mid \langle\langle x \geq g \rangle\rangle\varphi \mid \llbracket x < g \rrbracket\varphi \mid (a, x)\varphi.$$

As usual, to provide the semantics of a predicative logic, it is necessary to define the concept of free and bound *placeholders* of a formula. As for SL, since strategies can be associated to both agents and variables, we need the set of *free agents/variables* $\text{free}(\varphi)$ as the subset of $\text{Ag} \cup \text{Vr}$ containing (i) all agents a for which there is no binding (a, x) before the occurrence of an atomic proposition and (ii) all variables x for which there is a binding (a, x) but no quantification $\langle\langle x \geq g \rangle\rangle$ or $\llbracket x < g \rrbracket$.

Definition 2.3 (GSL Free Agents/Variables). *The set of free agents/variables of a GSL formula is given by the function $\text{free} : \text{GSL} \rightarrow 2^{\text{Ag} \cup \text{Vr}}$ such that:*

1. $\text{free}(p) \triangleq \text{Ag}$, with $p \in \text{AP}$;
2. $\text{free}(\neg\varphi) \triangleq \text{free}(\varphi)$;
3. $\text{free}(\varphi_1 \vee \varphi_2) \triangleq \text{free}(\varphi_1) \cup \text{free}(\varphi_2)$;
4. $\text{free}(\varphi_1 \wedge \varphi_2) \triangleq \text{free}(\varphi_1) \cup \text{free}(\varphi_2)$;
5. $\text{free}(X\varphi) \triangleq \text{Ag} \cup \text{free}(\varphi)$;
6. $\text{free}(\varphi_1 \text{Op} \varphi_2) \triangleq \text{Ag} \cup \text{free}(\varphi_1) \cup \text{free}(\varphi_2)$ with $\text{Op} \in \{\text{U}, \text{R}\}$;
7. $\text{free}(\langle\langle x \geq g \rangle\rangle\varphi) \triangleq \text{free}(\varphi) \setminus \{x\}$;
8. $\text{free}(\llbracket x < g \rrbracket\varphi) \triangleq \text{free}(\varphi) \setminus \{x\}$;
9. $\text{free}((a, x)\varphi) \triangleq \text{free}(\varphi)$, if $a \notin \text{free}(\varphi)$, with $a \in \text{Ag}$ and $x \in \text{Vr}$;
10. $\text{free}((a, x)\varphi) \triangleq (\text{free}(\varphi) \setminus \{a\}) \cup \{x\}$, if $a \in \text{free}(\varphi)$, with $a \in \text{Ag}$ and $x \in \text{Vr}$.

A formula φ without free agents (resp., variables), *i.e.*, with $\text{free}(\varphi) \cap \text{Ag} = \emptyset$ (resp., $\text{free}(\varphi) \cap \text{Vr} = \emptyset$), is named *agent-closed* (resp., *variable-closed*). A *sentence* is a both agent- and variable-closed formula. Since a variable x may be bound to more than a single agent at the time, we also need the subset $\text{shr}(\varphi, x)$ of Ag containing those agents for which a binding (a, x) occurs in φ .

Definition 2.4 (GSL Shared Variables). *The set of shared variables of a GSL formula is given by the function $\text{shr} : \text{GSL} \times \text{Vr} \rightarrow 2^{\text{Ag}}$ such that:*

1. $\text{shr}(p, x) \triangleq \emptyset$, with $p \in \text{AP}$;
2. $\text{shr}(\neg\varphi, x) \triangleq \text{shr}(\varphi, x)$;
3. $\text{shr}(\varphi_1 \vee \varphi_2, x) \triangleq \text{shr}(\varphi_1, x) \cup \text{shr}(\varphi_2, x)$;
4. $\text{shr}(\varphi_1 \wedge \varphi_2, x) \triangleq \text{shr}(\varphi_1, x) \cup \text{shr}(\varphi_2, x)$;
5. $\text{shr}(X\varphi, x) \triangleq \text{shr}(\varphi, x)$;
6. $\text{shr}(\varphi_1 \text{Op} \varphi_2, x) \triangleq \text{shr}(\varphi_1, x) \cup \text{shr}(\varphi_2, x)$ with $\text{Op} \in \{\text{U}, \text{R}\}$;
7. $\text{shr}(\langle\langle x \geq g \rangle\rangle\varphi, x) \triangleq \text{shr}(\varphi, x)$;
8. $\text{shr}(\llbracket x < g \rrbracket\varphi, x) \triangleq \text{shr}(\varphi, x)$;
9. $\text{shr}((a, y)\varphi, x) \triangleq \text{shr}(\varphi, x)$, if $a \notin \text{free}(\varphi)$ or $y \neq x$, with $a \in \text{Ag}$ and $y \in \text{Vr}$;
10. $\text{shr}((a, x)\varphi, x) \triangleq \text{shr}(\varphi, x) \cup \{a\}$, if $a \in \text{free}(\varphi)$, with $a \in \text{Ag}$.

For complexity reasons, we restrict to the *One-Goal* fragment of GSL (GSL[1G], for short), which is the graded extension of SL[1G] [36]. To formalize its syntax, we first introduce some notions. A *quantification prefix* over a set $V \subseteq \text{Vr}$ of variables is a word $\varphi \in \{\langle\langle x \geq g \rangle\rangle, \llbracket x < g \rrbracket : x \in V \wedge g \in \mathbb{N}\}^{|V|}$ of length $|V|$ such that each $x \in V$ occurs just once in φ . With $\text{Qn}(V)$ we indicate

the set of quantification prefixes over V . A *binding prefix* over $A \subseteq \text{Ag}$ is a word $b \in \{(a, x) : a \in A \wedge x \in \text{Vr}\}^{|A|}$ such that each $a \in A$ occurs exactly once in b . By Bn we indicate the set of all binding prefixes. $\text{GSL}[1\text{G}]$ restricts GSL by forcing, after a quantification prefix, a single goal to occur *i.e.*, a formula of the kind $b\psi$, where b is a binding prefix on all the agents in Ag . The syntax of $\text{GSL}[1\text{G}]$ follows.

Definition 2.5 ($\text{GSL}[1\text{G}]$ Syntax). $\text{GSL}[1\text{G}]$ formulas are built inductively through the following grammar:

$$\varphi := p \mid \neg\varphi \mid \varphi \wedge \varphi \mid \varphi \vee \varphi \mid \mathbf{X}\varphi \mid \varphi\mathbf{U}\varphi \mid \varphi\mathbf{R}\varphi \mid \wp b\varphi,$$

with \wp quantification prefix over $\text{free}(b\varphi)$ and $b\varphi$ a goal.

As an example of $\text{GSL}[1\text{G}]$ property, in the context of the scheduler system, consider the sentence $\varphi = \wp b\psi$, with $\wp = \langle\langle \mathbf{x} \geq k \rangle\rangle \llbracket \mathbf{y}_1 < g_1 \rrbracket \llbracket \mathbf{y}_2 < g_2 \rrbracket$, $b = (\mathbf{A}, \mathbf{x})(\mathbf{P}_1, \mathbf{y}_1)(\mathbf{P}_2, \mathbf{y}_2)$, and $\psi = \mathbf{F}(\mathbf{r}_1 \vee \mathbf{r}_2)$. It says that there are at least k strategies for the arbiter \mathbf{A} ensuring that one between the processes \mathbf{P}_1 and \mathbf{P}_2 receives the resource, being them able to avoid less than g_1 and g_2 strategies, respectively.

2.3. Semantics

As for SL , the interpretation of a GSL formula requires a valuation for its free placeholders. This is done via *assignments*, *i.e.*, partial functions $\chi \in \text{Asg} \triangleq (\text{Vr} \cup \text{Ag}) \rightarrow \text{Str}$ mapping variables/agents to strategies. An assignment χ is *complete* if it is defined on all agents in Ag , *i.e.*, $\chi(a) \in \text{Str}(\{a\})$, for all $a \in \text{Ag} \subseteq \text{dom}(\chi)$. In this case, it directly identifies the profile $\chi \upharpoonright_{\text{Ag}}$ given by the restriction of χ to Ag . In addition, $\chi[e \mapsto \sigma]$, with $e \in \text{Vr} \cup \text{Ag}$ and $\sigma \in \text{Str}$, denotes the assignment defined on $\text{dom}(\chi[e \mapsto \sigma]) \triangleq \text{dom}(\chi) \cup \{e\}$ that differs from χ only on the fact that e is associated with σ . Formally, $\chi[e \mapsto \sigma](e) = \sigma$ and $\chi[e \mapsto \sigma](e') = \chi(e')$, for all $e' \in \text{dom}(\chi) \setminus \{e\}$. For a state $s \in \text{St}$, it is said that χ is *s-total* if all strategies $\chi(l)$ are *s-total*, for $l \in \text{dom}(\chi)$. The set $\text{Asg} \triangleq \text{Vr} \cup \text{Ag} \rightarrow \text{Str}$ (resp., $\text{Asg}(s) \triangleq \text{Vr} \cup \text{Ag} \rightarrow \text{Str}(s)$) contains all (resp., *s-total*) assignments. Moreover, $\text{Asg}(\mathbf{X}) \triangleq \mathbf{X} \rightarrow \text{Str}$ (resp., $\text{Asg}(\mathbf{X}, s) \triangleq \mathbf{X} \rightarrow \text{Str}(s)$) indicates the subset of \mathbf{X} -defined (resp., *s-total*) assignments, *i.e.*, (resp., *s-total*) assignments defined on the set $\mathbf{X} \subseteq \text{Vr} \cup \text{Ag}$. Finally, for a formula φ , we say that χ is *φ -coherent* iff (i) $\text{free}(\varphi) \subseteq \text{dom}(\chi)$, (ii) $\chi(a) \in \text{Str}(\{a\})$, for all $a \in \text{dom}(\chi) \cap \text{Ag}$, and (iii) $\chi(x) \in \text{Str}(\text{shr}(\varphi, x))$, for all $x \in \text{dom}(\chi) \cap \text{Vr}$. To provide the semantics of GSL , we give a definition of *update state/assignment* which is used to calculate, at a certain step of the play, what the current state and its updated assignment are. For a given state $s \in \text{St}$ and a complete *s-total* assignment $\chi \in \text{Asg}(s)$, the i -th update state/assignment of (χ, s) , with $i \in \mathbb{N}$, is the pair of a complete assignment and a state $(\chi, s)^i \triangleq ((\chi)_{(\pi)_{\leq i}}, (\pi)_i)$ where $\pi = \text{play}(\chi, s)$. In other words, $(\chi, s)^i$ corresponds to the i -th element of the sequence, given a partial assignments $(\chi)_{(\pi)_{\leq i}}$.

We now define the semantics of a GSL formula φ *w.r.t.* a CGS \mathcal{G} and a φ -coherent assignment χ . In particular, we write $\mathcal{G}, \chi \models \varphi$ to indicate that φ

holds in \mathcal{G} under χ . The semantics of LTL formulas and agent bindings are defined as in SL. The definition of graded strategy quantifiers, instead, makes use of a family of equivalence relations $\equiv_{\mathcal{G}}^{\varphi}$ on assignments that depend on the structure \mathcal{G} and the considered formula φ . This equivalence is used to reasonably count the number of strategies that satisfy a formula *w.r.t.* an *a priori* fixed criterion. Observe that we use a relation on assignments instead of a more direct one on strategies, since the classification may also depend on the context determined by the strategies previously quantified. In Section 3, we will come back to the properties the equivalence relation has to satisfy in order to be used in the semantics of GSL.

Definition 2.6 (GSL Semantics). *Let \mathcal{G} be a CGS, φ be a GSL formula and $s \in \text{St}$ be a state. For all φ -coherent assignments $\chi \in \text{Asg}$, the relation $\mathcal{G}, \chi, s \models \varphi$ is inductively defined as follows.*

1. For every $p \in \text{AP}$, it holds that $\mathcal{G}, \chi, s \models p$ iff $p \in \text{ap}(s)$.
2. For all formulas φ, φ_1 , and φ_2 , it holds that:
 - (a) $\mathcal{G}, \chi, s \models \neg\varphi$ iff $\mathcal{G}, \chi, s \not\models \varphi$;
 - (b) $\mathcal{G}, \chi, s \models \varphi_1 \wedge \varphi_2$ iff $\mathcal{G}, \chi, s \models \varphi_1$ and $\mathcal{G}, \chi, s \models \varphi_2$;
 - (c) $\mathcal{G}, \chi, s \models \varphi_1 \vee \varphi_2$ iff $\mathcal{G}, \chi, s \models \varphi_1$ or $\mathcal{G}, \chi, s \models \varphi_2$.
3. For each $x \in \text{Vr}$, $g \in \mathbb{N}$, and $\varphi \in \text{GSL}$, it holds that:
 - (a) $\mathcal{G}, \chi, s \models \langle\langle x \geq g \rangle\rangle\varphi$ iff $|(\{\chi[x \mapsto \sigma] : \sigma \in \varphi[\mathcal{G}, \chi, s](x)\} / \equiv_{\mathcal{G}}^{\varphi})| \geq g$;
 - (b) $\mathcal{G}, \chi, s \models \llbracket x < g \rrbracket\varphi$ iff $|(\{\chi[x \mapsto \sigma] : \sigma \in \neg\varphi[\mathcal{G}, \chi, s](x)\} / \equiv_{\mathcal{G}}^{\neg\varphi})| < g$;

where $\eta[\mathcal{G}, \chi, s](x) \triangleq \{\sigma \in \text{Str}(\text{shr}(\eta, x)) : \mathcal{G}, \chi[x \mapsto \sigma], s \models \eta\}$ is the set of $\text{shr}(\eta, x)$ -coherent strategies that, being assigned to x in χ , satisfy η .
4. For each $a \in \text{Ag}$, $x \in \text{Vr}$, and $\varphi \in \text{GSL}$, it holds that $\mathcal{G}, \chi, s \models (a, x)\varphi$ iff $\mathcal{G}, \chi[a \mapsto \chi(x)], s \models \varphi$.
5. Finally, if the assignment χ is also complete, for all formulas φ, φ_1 , and φ_2 , it holds that:
 - (a) $\mathcal{G}, \chi, s \models \mathbf{X}\varphi$ iff $\mathcal{G}, (\chi, s)^1 \models \varphi$;
 - (b) $\mathcal{G}, \chi, s \models \varphi_1 \mathbf{U} \varphi_2$ if there is an index $i \in \mathbb{N}$ such that $\mathcal{G}, (\chi, s)^i \models \varphi_2$ and, for all indexes $j \in \mathbb{N}$ with $j < i$, it holds that $\mathcal{G}, (\chi, s)^j \models \varphi_1$;
 - (c) $\mathcal{G}, \chi, s \models \varphi_1 \mathbf{R} \varphi_2$ if, for all indexes $i \in \mathbb{N}$, it holds that $\mathcal{G}, (\chi, s)^i \models \varphi_2$ or, there is an index $j \in \mathbb{N}$ with $j < i$, such that $\mathcal{G}, (\chi, s)^j \models \varphi_1$.

Intuitively, the existential quantifier $\langle\langle x \geq g \rangle\rangle\varphi$ allows us to count the number of equivalence classes *w.r.t.* $\equiv_{\mathcal{G}}^{\varphi}$ over the set of assignments $\{\chi[x \mapsto \sigma] : \sigma \in \varphi[\mathcal{G}, \chi](x)\}$ that, extending χ , satisfy φ . The universal quantifier $\llbracket x < g \rrbracket\varphi$ is the dual of $\langle\langle x \geq g \rangle\rangle\varphi$ and counts how many classes *w.r.t.* $\equiv_{\mathcal{G}}^{\neg\varphi}$ there are over the assignments $\{\chi[x \mapsto \sigma] : \sigma \in \neg\varphi[\mathcal{G}, \chi](x)\}$ that, extending χ , do not satisfy φ . Note that all GSL formulas with degree 1 are SL formulas, since with $\langle\langle \mathbf{x} \geq 1 \rangle\rangle\varphi$ is appropriate to find a single strategy that satisfies the formula, just like $\langle\langle \mathbf{x} \rangle\rangle\varphi$. Furthermore, by $\llbracket \mathbf{x} < 1 \rrbracket\varphi$ all strategies are considered, without excluding any, just like $\llbracket \mathbf{x} \rrbracket\varphi$. In order to complete the description of the semantics, we now give the classic notions of model and satisfiability of an GSL sentence. We say that

a CGS \mathcal{G} is a model of an GSL sentence φ , in symbols $\mathcal{G} \models \varphi$, if $\mathcal{G}, \emptyset, s_I \models \varphi$.² In general, we also say that \mathcal{G} is a model for φ on $s \in \text{St}$, in symbols $\mathcal{G}, s \models \varphi$, if $\mathcal{G}, \emptyset, s \models \varphi$. An GSL sentence φ is satisfiable if there is a model for it.

Consider again the sentence $\varphi = \langle\langle \mathbf{x} \geq k \rangle\rangle [\mathbf{y}_1 < g_1] [\mathbf{y}_2 < g_2] (\mathbf{A}, \mathbf{x})(\mathbf{P}_1, \mathbf{y}_1)(\mathbf{P}_2, \mathbf{y}_2) \mathbf{F}(\mathbf{r}_1 \vee \mathbf{r}_2)$ of the scheduler example. Once a reasonable equivalence relation on assignments is fixed (see Section 3), one can see that $\mathcal{G}_S \models \varphi$ with $k \geq 0$ and $(g_1, g_2) = (1, 2)$ but $\mathcal{G}_S \not\models \varphi$ with $(k, g_1, g_2) = (1, 1, 1)$. Indeed, if the processes use the same strategy, they may force the play to be in $(\mathbf{I}^+ \cdot \mathbf{W})^* \cdot \mathbf{I}^\omega + (\mathbf{I}^+ \cdot \mathbf{W})^\omega$, so they either avoid to do a request or relinquish a request that is not immediately served. Consequently, to satisfy φ , we need to verify the property against all but one strategy of \mathbf{P}_2 , *i.e.*, the one used by \mathbf{P}_1 . Under these assumptions, we can see that the arbiter \mathbf{A} has an infinite number of different strategies by suitably choosing the actions on all histories ending in the state \mathbf{W} .

2.4. Results

In this section, we summarize the main results we have obtained on GSL along this paper. We start showing that graded ATL (GATL) [31] is strictly included in $\text{GSL}[1\mathbf{G}]$. Precisely, we first show that GATL can be translated into $\text{GSL}[1\mathbf{G}]$, then we provide a formula $\text{GSL}[1\mathbf{G}]$ and show that it cannot be expressed in GATL. In [31], the authors introduce two different semantics for GATL, called *off-line* and *on-line*, and it has been showed that this logic has the ability to count how many different strategies (in the off-line semantics) or paths (in the on-line semantics) satisfy a certain property. Under the off-line semantics, over a CGS with agents α and $\bar{\alpha}$, the GATL formula $\langle\langle \alpha \rangle\rangle^g \psi$ is equivalent to the $\text{GSL}[1\mathbf{G}]$ sentence $\langle\langle \mathbf{x} \geq g \rangle\rangle [\bar{\mathbf{x}} < 1](\alpha, \mathbf{x})(\bar{\alpha}, \bar{\mathbf{x}})\psi$. Under the on-line semantics, instead, it is equivalent to the sentence $[\bar{\mathbf{x}} < 1] \langle\langle \mathbf{x} \geq g \rangle\rangle (\alpha, \mathbf{x})(\bar{\alpha}, \bar{\mathbf{x}})\psi$. Note that the counting over strategies in GATL is limited to existential agents and, so, the $\text{GSL}[1\mathbf{G}]$ formula $[\bar{\mathbf{x}} < 2] \langle\langle \mathbf{y} \geq 1 \rangle\rangle (\alpha, \mathbf{x})(\bar{\alpha}, \mathbf{y})\psi$ does not have any ATL equivalent formula. From these considerations, we derive the following theorem.

Theorem 2.1. *$\text{GSL}[1\mathbf{G}]$ is more expressive of GATL.*

It is important to note that the criteria used for the strategy classification in GATL is strictly coupled with the temporal operators $\mathbf{X}\varphi$, $\varphi_1 \mathbf{U} \varphi_2$, and $\mathbf{G}\varphi$ along the syntax, and we do not see how this can be extended to the whole LTL, unless one uses the approach proposed in [16].

Another important result we prove in Section 5 is the determinacy for $\text{GSL}[1\mathbf{G}]$ in the case of 2 variables as stated in the following theorem.

Theorem 2.2 (Determinacy). *$\text{GSL}[1\mathbf{G}, 2\mathbf{AG}]$ on Turn-Based Game Structures is determined.*

Finally, in Section 6, we solve the model checking problem for the vanilla fragment of $\text{GSL}[1\mathbf{G}]$ with 2 variables. As for ATL, *Vanilla* $\text{GSL}[1\mathbf{G}]$ requires

²The symbol \emptyset stands for the empty function.

that two successive temporal operators in a formula are always interleaved by a strategy quantifier.

Theorem 2.3 (Model Checking). *The model-checking problem for Vanilla GSL[1G] is PTIME-COMPLETE w.r.t. the size of the structure and the sentence.*

3. Strategy Equivalence

Our definition of the GSL semantics makes use of an arbitrary family of equivalence relation on assignments. This choice introduces flexibility in its description, since one can come up with different logics by opportunely choosing different equivalences. In this section, we focus on a particular relation whose key feature is to classify as equivalent all assignments that reflect the same “*strategic reasoning*”, although they may have completely different structures. Just to get an intuition about what we mean, consider two assignments χ_1 and χ_2 and the corresponding involved strategies associated with the agents \mathbf{a}_1 and \mathbf{a}_2 . Assume now that, for each $i \in \{1, 2\}$, the homologous strategies $\chi_1(\mathbf{a}_i)$ and $\chi_2(\mathbf{a}_i)$ only differ on histories never met by a play because of a specific combination of their actions. Clearly, χ_1 and χ_2 induce the same agent behaviors, which means to reflect the same strategic reasoning. Therefore, it is natural to set them as equivalent, as we do. Two formulas are considered equivalent whenever the two assignments are equivalent for both or none of them. Also, if two assignments do not satisfy the same formulas, they are not equivalent.

In the sequel, in order to illustrate the introduced concepts, we analyze subformulas of the previously described sentence $\langle\langle \mathbf{x} \geq k \rangle\rangle [\mathbf{y}_1 < 1] [\mathbf{y}_2 < 2] (\mathbf{A}, \mathbf{x})(\mathbf{P}_1, \mathbf{y}_1)(\mathbf{P}_2, \mathbf{y}_2) \mathbf{F}(\mathbf{r}_1 \vee \mathbf{r}_2)$, together with their negations, over the CGS \mathcal{G}_S of Figure 1.

3.1. Elementary Requirements

Logics usually admit syntactic redundancy. For example, in LTL we have $\neg \mathbf{X}(\mathbf{p} \wedge \mathbf{q}) \equiv \mathbf{X}\neg(\mathbf{p} \wedge \mathbf{q}) \equiv \mathbf{X}(\neg \mathbf{p} \vee \neg \mathbf{q})$. Also, the semantics is normally closed under substitution. Yet for LTL, this means that $\neg \mathbf{X}(\mathbf{p} \wedge \mathbf{q})$ can be replaced with $\mathbf{X}\neg(\mathbf{p} \wedge \mathbf{q})$ or $\mathbf{X}(\neg \mathbf{p} \vee \neg \mathbf{q})$, without changing the meaning of a formula. GSL should not be an exception. To ensure this, we require the invariance of the equivalence relation on assignments *w.r.t.* the syntax of the involved formulas.

Definition 3.1 (Syntax Independence). *An equivalence relation on assignments $\equiv_{\mathcal{G}}$ is syntax independent if, for any pair of equivalent formulas φ_1 and φ_2 and ($\text{free}(\varphi_1) \cup \text{free}(\varphi_2)$)-coherent assignments $\chi_1, \chi_2 \in \text{Asg}$, we have that $\chi_1 \equiv_{\mathcal{G}}^{\varphi_1} \chi_2$ iff $\chi_1 \equiv_{\mathcal{G}}^{\varphi_2} \chi_2$.*

As declared above, our aim is to classify as equivalent *w.r.t.* a formula φ all assignments that induce the same strategic reasoning. Therefore, we cannot distinguish them *w.r.t.* the satisfiability of φ itself.

Definition 3.2 (Semantic Consistency). *An equivalence relation on assignments $\equiv_{\mathcal{G}}$ is semantically consistent if, for any formula φ and φ -coherent assignments $\chi_1, \chi_2 \in \text{Asg}$, we have that if $\chi_1 \equiv_{\mathcal{G}}^{\varphi} \chi_2$ then either $\mathcal{G}, \chi_1 \models \varphi$ and $\mathcal{G}, \chi_2 \models \varphi$ or $\mathcal{G}, \chi_1 \not\models \varphi$ and $\mathcal{G}, \chi_2 \not\models \varphi$.*

3.2. Play Requirement

We now deal with the equivalence relation for the basic case of temporal properties. Before disclosing the formalization, we give an intuition on how to evaluate the equivalence of two complete assignments χ_1 and χ_2 *w.r.t.* their agreement on the verification of a generic LTL property ψ . Let π_1 and π_2 with $\pi_1 \neq \pi_2$ be the plays satisfying ψ induced by χ_1 and χ_2 , respectively. Also, consider their maximal common prefix $\rho = \text{prf}(\pi_1, \pi_2) \in \text{Hst}$. If ρ can be extended to a play in such a way that ψ does not hold, we are sure that the reasons why both the assignments satisfy the property are different, as they reside in the parts where the two plays diverge. Consequently, we can assume χ_1 and χ_2 to be non-equivalent *w.r.t.* ψ . Conversely, if all infinite extensions of ρ necessarily satisfy ψ , we may affirm that this is already a witness of the verification of the property by the two plays and, so, by the two assignments. Hence, we can assume χ_1 and χ_2 to be equivalent *w.r.t.* ψ .

In the following, we often make use of the concept of witness of an LTL formula ψ as the set $W_\psi \triangleq \{\rho \in \text{Hst} : \forall \pi \in \text{Pth} . \rho < \pi \Rightarrow \pi \models \psi\}$ containing all histories that cannot be extended to a play violating the property.

Definition 3.3 (Play Consistency). *An equivalence relation on assignments $\equiv_{\mathcal{G}}$ is play consistent if, for any LTL formula ψ and ψ -coherent assignments $\chi_1, \chi_2 \in \text{Asg}$, we have that $\chi_1 \equiv_{\mathcal{G}}^\psi \chi_2$ iff either $\pi_1 = \pi_2$ or $\text{prf}(\pi_1, \pi_2) \in W_\psi$, where $\pi_1 = \text{play}(\chi_1 \upharpoonright_{\text{Asg}}, s_I)$ and $\pi_2 = \text{play}(\chi_2 \upharpoonright_{\text{Asg}}, s_I)$ are the plays induced by χ_1 and χ_2 , respectively, and $W_\psi \subseteq \text{Hst}$ is the witness set of ψ .*

To see how to apply the above definition, consider the formula $\psi = \text{F}(\mathbf{r}_1 \vee \mathbf{r}_2)$ and let W_ψ be the corresponding witness set, whose minimal histories can be represented by the regular expression $\text{I}^+ \cdot (1 + 2) + (\text{I}^+ \cdot \text{W})^+ \cdot (1 + 2 + 1/2 + 2/1)$. Moreover, let $\chi_1, \chi_2, \chi_3 \in \text{Asg}(\{\mathbf{A}, \mathbf{P}_1, \mathbf{P}_2\})$ be three complete assignments on which we want to check the play consistency. We assume that each χ_i associates a strategy $\chi_i(\mathbf{a}) = \sigma_i^{\mathbf{a}}$ with the agent $\mathbf{a} \in \{\mathbf{A}, \mathbf{P}_1, \mathbf{P}_2\}$ as defined in the following, where $\rho, \rho' \in \text{Hst}$ with $\text{lst}(\rho') \neq \text{I}$: for the arbiter \mathbf{A} , we set $\sigma_{1/2}^{\mathbf{A}}(\rho \cdot \text{W}) \triangleq 2$, $\sigma_{1/2/3}^{\mathbf{A}}(\rho \cdot 1/2) = \sigma_2^{\mathbf{A}}(\rho \cdot 2/1) \triangleq \mathbf{i}$, and $\sigma_3^{\mathbf{A}}(\rho \cdot \text{W}) = \sigma_{1/3}^{\mathbf{A}}(\rho \cdot 2/1) \triangleq \mathbf{1}$; for the processes, instead, we set $\sigma_{1/2/3}^{\mathbf{P}_1}(\rho') = \sigma_{1/2/3}^{\mathbf{P}_2}(\rho') \triangleq \mathbf{i}$, $\sigma_{1/2}^{\mathbf{P}_1}(\rho \cdot \text{I}) = \sigma_{1/2/3}^{\mathbf{P}_2}(\rho \cdot \text{I}) \triangleq \mathbf{r}$, and $\sigma_3^{\mathbf{P}_1}(\rho \cdot \text{I}) \triangleq \mathbf{i}^3$. Now, one can see that $\chi_1 \equiv_{\mathcal{G}}^\psi \chi_2$, but $\chi_1 \not\equiv_{\mathcal{G}}^\psi \chi_3$. Indeed, χ_1, χ_2 , and χ_3 induce the plays $\pi_1 = \text{I} \cdot \text{W} \cdot 2/1 \cdot 1/2^\omega$, $\pi_2 = \text{I} \cdot \text{W} \cdot 2/1^\omega$, and $\pi_3 = \text{I} \cdot 2^\omega$, respectively, where $\rho_{12} = \text{prf}(\pi_1, \pi_2) = \text{I} \cdot \text{W} \cdot 2/1$ and $\rho_{13} = \text{prf}(\pi_1, \pi_3) = \text{I}$ are the corresponding common prefixes. Thus, ρ_{12} belongs to the witness W_ψ , while ρ_{13} does not.

As another example, consider the formula $\bar{\psi} = \text{G}(\neg \mathbf{r}_1 \wedge \neg \mathbf{r}_2)$, which is equivalent to the negation of the previous one, and observe that its witness set $W_{\bar{\psi}}$ is empty. Moreover, let $\chi_1, \chi_2, \chi_3 \in \text{Asg}(\{\mathbf{A}, \mathbf{P}_1, \mathbf{P}_2\})$ be the three complete assignments we want to analyze. The strategies for the arbiter \mathbf{A} are defined

³Note that, we use $\sigma_{i/j}^{\mathbf{a}}(\rho) = \alpha$ to represent $\sigma_i^{\mathbf{a}}(\rho) = \alpha$ and $\sigma_j^{\mathbf{a}}(\rho) = \alpha$.

as above, while those of the processes follows: $\bar{\sigma}_{1/2/3}^{P_i}(\rho') \triangleq \mathbf{i}$, $\bar{\sigma}_{1/2}^{P_i}(\rho \cdot \mathbf{I}) \triangleq \mathbf{r}$, $\bar{\sigma}_{1/2}^{P_i}(\rho \cdot \mathbf{W}) \triangleq \mathbf{a}$, and $\bar{\sigma}_3^{P_i}(\rho \cdot \mathbf{I}) = \bar{\sigma}_3^{P_i}(\rho \cdot \mathbf{W}) \triangleq \mathbf{i}$, where $i \in \{1, 2\}$ and $\rho, \rho' \in \text{Hst}$ with $\text{lst}(\rho') \notin \{\mathbf{I}, \mathbf{W}\}$. Now, one can see that $\chi_1 \equiv_{\mathcal{G}}^{\bar{\psi}} \chi_2$, but $\chi_1 \not\equiv_{\mathcal{G}}^{\bar{\psi}} \chi_3$. Indeed, χ_1 and χ_2 induce the same play $(\mathbf{I} \cdot \mathbf{W})^\omega$, while χ_3 runs along \mathbf{I}^ω . Thus, χ_1 and χ_2 are equivalent, but χ_1 and χ_3 are not.

3.3. Strategy Requirements

The semantics of a binding construct $\varphi = (a, x)\eta$ involves a redefinition of the underlying assignment χ , as it asserts that φ holds under χ once the inner part η is satisfied by associating the agent a to the strategy $\chi(x)$. Thus, the equivalence of two assignments χ_1 and χ_2 *w.r.t.* φ necessarily depends on that of their extensions on a *w.r.t.* η .

Definition 3.4 (Binding Consistency). *An equivalence relation on assignments $\equiv_{\mathcal{G}}$ is binding consistent if, for a formula $\varphi = (\mathbf{a}, \mathbf{x})\eta$ and φ -coherent assignments $\chi_1, \chi_2 \in \text{Asg}$, we have that $\chi_1 \equiv_{\mathcal{G}}^{\varphi} \chi_2$ iff $\chi_1[\mathbf{a} \mapsto \chi_1(\mathbf{x})] \equiv_{\mathcal{G}}^{\eta} \chi_2[\mathbf{a} \mapsto \chi_2(\mathbf{x})]$.*

To get familiar with the above concept, consider the formula $b\psi$, where $b \triangleq (\mathbf{A}, \mathbf{x})(P_1, \mathbf{y}_1)(P_2, \mathbf{y}_2)$, and let $\chi_1, \chi_2, \chi_3 \in \text{Asg}(\{\mathbf{x}, \mathbf{y}_1, \mathbf{y}_2\})$ be the assignments assuming as values the strategies $\chi_i(\mathbf{x}) \triangleq \sigma_i^{\mathbf{A}}$ and $\chi_i(\mathbf{y}_j) \triangleq \sigma_i^{P_j}$ previously defined, where $i \in \{1, 2, 3\}$ and $j \in \{1, 2\}$. Then, by definition, it is immediate to see that $\chi_1 \equiv_{\mathcal{G}}^{b\psi} \chi_2$, but $\chi_1 \not\equiv_{\mathcal{G}}^{b\psi} \chi_3$.

Before continuing with the analysis of the equivalence, it is worth making same reasoning about the dual nature of the existential and universal quantifiers *w.r.t.* the counting of strategies. We do this by exploiting the classic game-semantics metaphor originally proposed for first-order logic by Lorenzen and Hintikka, where the choice of an existential variable is done by a player called \exists and that of the universal ones by its opponent \forall . Consider a sentence $\langle\langle x_1 \geq g_1 \rangle\rangle \llbracket x_2 < g_2 \rrbracket \eta$, having $\langle\langle y_1 \geq h_1 \rangle\rangle \eta_1$ and $\llbracket y_2 < h_2 \rrbracket \eta_2$ as two subformulas in η . When player \exists tries to choose h_1 different strategies \mathbf{y}_1 to satisfy η_1 , it also has to maximize the number of strategies x_1 by verifying $\llbracket x_2 < g_2 \rrbracket \eta$ to be sure that the constraint $\geq g_1$ of the first quantification is not violated. At the same time, player \forall tries to do the opposite while choosing h_2 different strategies y_2 not satisfying η_2 , *i.e.*, it needs to maximize the number of strategies x_2 falsifying η in order to violate the constraint $< g_2$ of the second quantifier.

With the above observation in mind, we now treat the equivalence for the existential quantifier. Two assignments χ_1 and χ_2 are equivalent *w.r.t.* a formula $\varphi = \langle\langle x \geq g \rangle\rangle \eta$ if player \exists is not able to find a strategy σ among those satisfying η , to associate with the variable x , that allows the corresponding extensions of χ_1 and χ_2 on x to induce different behaviors *w.r.t.* η . In other words, \exists cannot distinguish between the two assignments, as they behave the same independently of the way they are extended.

Definition 3.5 (Existential Consistency). *An equivalence relation on assignments $\equiv_{\mathcal{G}}$ is existentially consistent if, for any formula $\varphi = \langle\langle \mathbf{x} \geq g \rangle\rangle \eta$ and*

φ -coherent assignments $\chi_1, \chi_2 \in \text{Asg}$, we have that $\chi_1 \equiv_{\mathcal{G}}^{\varphi} \chi_2$ iff, for each strategy $\sigma \in \eta[\mathcal{G}, \chi_1](\mathbf{x}) \cup \eta[\mathcal{G}, \chi_2](\mathbf{x})$, it holds that $\chi_1[\mathbf{x} \mapsto \sigma] \equiv_{\mathcal{G}}^{\eta} \chi_2[\mathbf{x} \mapsto \sigma]$.

To clarify the above definition, consider the formula $\varphi = \langle\langle y_2 \geq 2 \rangle\rangle b\bar{\psi}$ and let $\chi_1, \chi_2, \chi_3 \in \text{Asg}(\{\mathbf{x}, \mathbf{y}_1\})$ be the three assignments having as values the strategies $\chi_i(\mathbf{x}) \triangleq \bar{\sigma}_i^A$ and $\chi_i(\mathbf{y}_1) \triangleq \bar{\sigma}_i^{P_1}$ previously defined, where $i \in \{1, 2, 3\}$. By a matter of calculation, one can see that $\chi_1 \equiv_{\mathcal{G}}^{\varphi} \chi_2$, but $\chi_1 \not\equiv_{\mathcal{G}}^{\varphi} \chi_3$. By definition, $\chi_1 \equiv_{\mathcal{G}}^{\varphi} \chi_2$ iff, for each strategy $\bar{\sigma} \in (b\bar{\psi})[\mathcal{G}, \chi_1](\mathbf{y}_2) \cup (b\bar{\psi})[\mathcal{G}, \chi_2](\mathbf{y}_2)$, it holds that $\chi_1[\mathbf{y}_2 \mapsto \bar{\sigma}] \equiv_{\mathcal{G}}^{b\bar{\psi}} \chi_2[\mathbf{y}_2 \mapsto \bar{\sigma}]$. Now, observe that the strategy $\bar{\sigma}_1^{P_2}$ introduced above is the unique one that allows χ_1 and χ_2 to satisfy $b\bar{\psi}$ once extended on \mathbf{y}_2 . At this point, we can easily show that $\chi_1[\mathbf{y}_2 \mapsto \bar{\sigma}_1^{P_2}] \equiv_{\mathcal{G}}^{b\bar{\psi}} \chi_2[\mathbf{y}_2 \mapsto \bar{\sigma}_1^{P_2}]$, as the derived complete assignments $\chi_1[\mathbf{y}_2 \mapsto \bar{\sigma}_1^{P_2}] \circ b$ and $\chi_2[\mathbf{y}_2 \mapsto \bar{\sigma}_1^{P_2}] \circ b$ induce the same play $(\mathbf{I} \cdot \mathbf{W})^{\omega}$. The non-equivalence of χ_1 and χ_3 easily follows from the fact that $\bar{\sigma}_1^{P_2} \notin (b\bar{\psi})[\mathcal{G}, \chi_3](\mathbf{y}_2)$, as $\chi_3[\mathbf{y}_2 \mapsto \bar{\sigma}_1^{P_2}] \circ b$ induces the play $\mathbf{I} \cdot 2^{\omega}$ that does not satisfy $\bar{\psi}$. Thus, $\chi_1[\mathbf{y}_2 \mapsto \bar{\sigma}_1^{P_2}] \not\equiv_{\mathcal{G}}^{b\bar{\psi}} \chi_3[\mathbf{y}_2 \mapsto \bar{\sigma}_1^{P_2}]$.

We conclude with the equivalence for the universal quantifier. Two assignments χ_1 and χ_2 are equivalent *w.r.t.* a formula $\varphi = \llbracket x < g \rrbracket \eta$ if, for each index $i \in \{1, 2\}$ and strategy σ_i player \forall chooses among those satisfying η under χ_i , there is a strategy σ_{3-i} this player can choose among those satisfying η under χ_{3-i} such that, once the two strategies are associated with the variable x , they make the corresponding extensions of assignments equivalent *w.r.t.* η . This means that the parts of the concurrent game structure that are reachable under χ_1 and χ_2 contain exactly the same information *w.r.t.* the verification of the inner formula. In other words, \forall cannot distinguish between the two assignments, as the induced subtrees of possible plays are practically the same.

Definition 3.6 (Universal Consistency). *An equivalence relation on assignments $\equiv_{\mathcal{G}}$ is universally consistent if, for any formula $\varphi = \llbracket \mathbf{x} < g \rrbracket \eta$ and φ -coherent assignments $\chi_1, \chi_2 \in \text{Asg}$, we have that $\chi_1 \equiv_{\mathcal{G}}^{\varphi} \chi_2$ iff, for all $i \in \{1, 2\}$ and strategy $\sigma_i \in \eta[\mathcal{G}, \chi_i](\mathbf{x})$, there is a strategy $\sigma_{3-i} \in \eta[\mathcal{G}, \chi_{3-i}](\mathbf{x})$ such that $\chi_1[\mathbf{x} \mapsto \sigma_1] \equiv_{\mathcal{G}}^{\eta} \chi_2[\mathbf{x} \mapsto \sigma_2]$.*

Finally, to better understand the above definition, consider the formula $\varphi = \llbracket y_1 < 1 \rrbracket \eta$, where $\eta = \llbracket y_2 < 2 \rrbracket b\psi$, and let $\chi_1, \chi_2, \chi_3 \in \text{Asg}(\{\mathbf{x}\})$ be the three assignments having as values the strategies $\chi_i(\mathbf{x}) \triangleq \sigma_i^A$ previously defined, where $i \in \{1, 2, 3\}$. One can see that $\chi_1 \equiv_{\mathcal{G}}^{\varphi} \chi_2$, but $\chi_1 \not\equiv_{\mathcal{G}}^{\varphi} \chi_3$.

First, observe that $\eta[\mathcal{G}, \chi_1](\mathbf{y}_1) = \eta[\mathcal{G}, \chi_2](\mathbf{y}_1) = \text{Str}$. Indeed, for all strategies $\sigma \in \text{Str}$, we have that $\mathcal{G}, \chi_1[\mathbf{y}_1 \mapsto \sigma] \models \eta$ and $\mathcal{G}, \chi_2[\mathbf{y}_1 \mapsto \sigma] \models \eta$, since $\mathcal{G}, \chi_1[\mathbf{y}_1 \mapsto \sigma, \mathbf{y}_2 \mapsto \sigma'] \models b\psi$ and $\mathcal{G}, \chi_2[\mathbf{y}_1 \mapsto \sigma, \mathbf{y}_2 \mapsto \sigma'] \models b\psi$, for all $\sigma' \in \text{Str}$ such that $\sigma \neq \sigma'$. This is due to the fact that the plays π_1 and π_2 induced by the two complete assignments $\chi_1[\mathbf{y}_1 \mapsto \sigma, \mathbf{y}_2 \mapsto \sigma'] \circ b$ and $\chi_2[\mathbf{y}_1 \mapsto \sigma, \mathbf{y}_2 \mapsto \sigma'] \circ b$ differ from $(\mathbf{I}^+ \cdot \mathbf{W})^* \cdot \mathbf{I}^{\omega}$ and $(\mathbf{I}^+ \cdot \mathbf{W})^{\omega}$, as the strategies of the two processes are different. Also, they share a common prefix $\rho = \text{prf}(\pi_1, \pi_2)$ belonging to \mathbf{W}_{ψ} , since the strategies of the arbiter only differ on the histories ending in the state 2/1. We can now show that χ_1 and χ_2 are equivalent, by applying the above definition in which we assume that $\sigma_i = \sigma_{3-i}$.

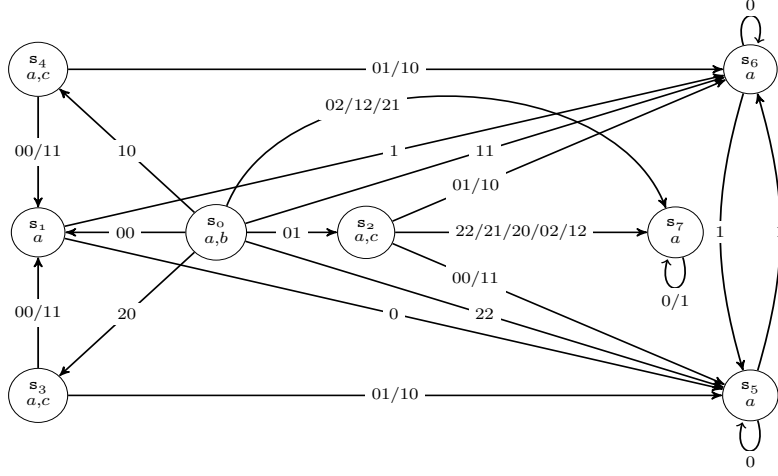

Figure 2: An example of CGS \mathcal{G} . Note that each node of \mathcal{G} is labeled with its name (in the upper part) and the subset of the players that are active in it (in the lower part).

To prove that χ_1 and χ_3 are non-equivalent, we show that there is a strategy $\sigma \in \eta[\mathcal{G}, \chi_1](\mathbf{y}_1)$ for χ_1 such that, for all strategies $\sigma' \in \eta[\mathcal{G}, \chi_3](\mathbf{y}_1)$ for χ_3 , it holds that $\chi_1[\mathbf{y}_1 \mapsto \sigma] \not\equiv_{\mathcal{G}}^{\eta} \chi_3[\mathbf{y}_1 \mapsto \sigma']$. As before, observe that $\eta[\mathcal{G}, \chi_1](\mathbf{y}_1) = \eta[\mathcal{G}, \chi_3](\mathbf{y}_1) = \text{Str}$ and choose $\sigma \in \text{Str}$ as the strategy $\sigma_1^{P_1}$ previously defined. At this point, one can easily see that all plays compatible with $\chi_1[\mathbf{y}_1 \mapsto \sigma] \circ b$ pass through either $I \cdot 1$ or $I \cdot W \cdot 2/1$, while a play compatible with $\chi_3 \circ b$ cannot pass through the latter history. Thus, the non-equivalence of the two assignments immediately follows.

4. From Concurrent To Turn-Based Games

In this section, we transform a game in a simpler but equivalent form. Precisely, we show how to transform a game from concurrent to turn-based. The definition of the turn-based structure follows.

Definition 4.1 (Turn-Based Game Structure). *A CGS \mathcal{G} is a Turn-Based Game Structure (TBGS, for short) if there exist a function $\text{own} : \text{St} \rightarrow \text{Ag}$, named owner function such that, for all states $s \in \text{St}$ and decisions $\delta_1, \delta_2 \in \text{Dc}$, it holds that if $\delta_1(\text{own}(s)) = \delta_2(\text{own}(s))$ then $\text{tr}(\delta_1)(s) = \text{tr}(\delta_2)(s)$.*

It is worth recalling that similar reductions have been also used to solve questions related to GATL in [31] and the one-goal fragment of SL in [37]. However, none of them can be used for $\text{GSL}[1\text{c}]$. The main reason resides in the fact that in both the mentioned cases, the reduction always results in a two-player game, where the two players represent a collapsing of all existential and

universal modalities, respectively. Conversely, in $\text{GSL}[1\text{G}]$ we need to maintain a multi-player setting in the construction. This is due to the fact that the technique employed in $\text{GSL}[1\text{G}]$ to count the non-equivalent strategies in a quantification, say $\langle\langle \mathbf{x} \geq g \rangle\rangle \varphi$, depends on the particular kind of quantifications and counting on the variables contained in its matrix, *i.e.*, φ . In particular, it is worth recalling that in GATL strategies are grouped together w.r.t. set of agents, while in $\text{GSL}[1\text{G}]$ every agent strategy is considered separately. Thus, we introduce an ad-hoc transformation of the concurrent game under exam into a multi-player turn-based one, which has the peculiarity of retaining the same number of variables, but can collapse equivalent actions. More precisely, starting with a game having k variables, we end in a game with k agents and k variables. The proposed conversion is divided into three parts. The first, called *normalization*, concerns the elimination of the bindings, where a different agent is introduced for every free variable. The second, named *minimization*, is the elimination of equivalent actions that are, therefore, redundant. Finally, the third is the real transformation of the game in a turn-based one. To better understand the three steps of the conversion, we consider the following running example.

Example 4.1. Consider the CGS $\mathcal{G} = \langle \text{AP}, \text{Ag}, \text{Ac}, \text{St}, \text{tr}, \text{ap}, s_I \rangle$ depicted in Figure 2, where $\text{AP} = \{p\}$, $\text{Ag} = \{\mathbf{a}, \mathbf{b}, \mathbf{c}\}$, $\text{Ac} = \{0, 1, 2\}$, $\text{St} = \{\mathbf{s}_0, \mathbf{s}_1, \mathbf{s}_2, \mathbf{s}_3, \mathbf{s}_4, \mathbf{s}_5, \mathbf{s}_6, \mathbf{s}_7\}$, and $s_I = \mathbf{s}_0$. Note that agent \mathbf{a} is active in all states, agent \mathbf{b} only in \mathbf{s}_0 , and agent \mathbf{c} in $\mathbf{s}_2, \mathbf{s}_3$, and \mathbf{s}_4 . Moreover, we have that $\text{ac}(\mathbf{s}_0, \mathbf{a}) = \text{ac}(\mathbf{s}_0, \mathbf{b}) = \text{ac}(\mathbf{s}_2, \mathbf{a}) = \text{ac}(\mathbf{s}_2, \mathbf{c}) = \{0, 1, 2\}$ and $\text{ac}(\mathbf{s}_1, \mathbf{a}) = \text{ac}(\mathbf{s}_1, \mathbf{c}) = \text{ac}(\mathbf{s}_3, \mathbf{a}) = \text{ac}(\mathbf{s}_3, \mathbf{c}) = \text{ac}(\mathbf{s}_4, \mathbf{a}) = \text{ac}(\mathbf{s}_4, \mathbf{c}) = \text{ac}(\mathbf{s}_5, \mathbf{a}) = \text{ac}(\mathbf{s}_6, \mathbf{a}) = \text{ac}(\mathbf{s}_7, \mathbf{a}) = \{0, 1\}$. Finally, the labeling function is defined as $\text{ap}(\mathbf{s}_0) = \text{ap}(\mathbf{s}_2) = \text{ap}(\mathbf{s}_3) = \text{ap}(\mathbf{s}_4) = \text{ap}(\mathbf{s}_7) = \emptyset$ and $\text{ap}(\mathbf{s}_1) = \text{ap}(\mathbf{s}_5) = \text{ap}(\mathbf{s}_6) = \{p\}$. The transition function is directly derivable from the figure.

4.1. Normalization

In this subsection, we introduce the concept of normalized CGS *w.r.t.* a given binding. The aim is to show how to turn a CGS \mathcal{G} in a new one \mathcal{G}^\bullet in which all agents associated with the same variable are merged into a single player. Basically, by applying the normalization, we restrict our attention to the part of the structure that is effectively involved in the verification of the formula *w.r.t.* a binding \mathfrak{b} . From a technical point of view, the normalization consists of two steps. The first transforms the set of variables into the set of agents; this means that all bindings become identities of the kind (x, x) . The second involves the transition function, which is augmented in order to associate decisions to the new agent (via the binding).

Construction 4.1 (CGS Normalization). From a CGS $\mathcal{G} = \langle \text{AP}, \text{Ag}, \text{Ac}, \text{St}, \text{tr}, \text{ap}, s_I \rangle$, a binding prefix $\mathfrak{b} \in \text{Bn}(\text{Ag})$ and $\text{GSL}[1\text{G}]$ formula $\varphi = \wp \mathfrak{b} \psi$, we build the normalized CGS $\mathcal{G}^\bullet \triangleq \langle \text{AP}, \text{Ag}^\bullet, \text{Ac}, \text{St}, \text{tr}^\bullet, \text{ap}, s_I \rangle$ as follows:

- the new agents in $\text{Ag}^\bullet \triangleq \text{rng}(\mathfrak{b})$ are all variables bounded by \mathfrak{b} , where $\text{rng} : \text{Bn} \rightarrow \text{Ag}$, *i.e.*, it returns all agents bounded by \mathfrak{b} .

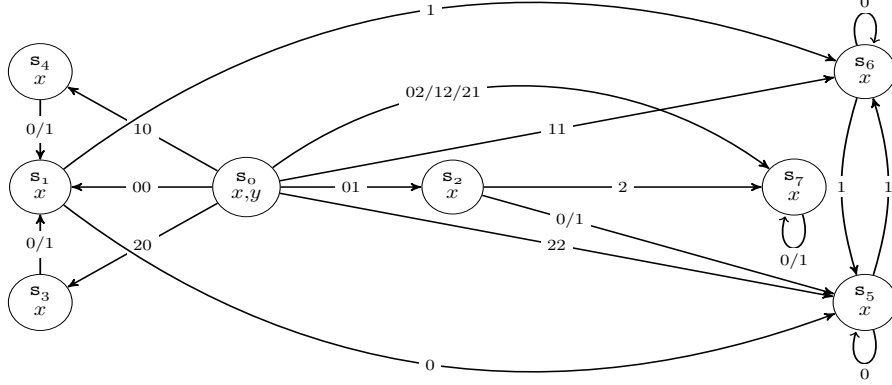

Figure 3: Normalized CGS \mathcal{G}^\bullet built on \mathcal{G} .

- the new transition function $\text{tr}^\bullet(\delta^\bullet)(s) \triangleq \text{tr}(\delta^\bullet \circ \flat)(s)$ simply maps a state $s \in \text{St}$ and a new active decision $\delta^\bullet \in \text{dc}^\bullet(s) \triangleq \{\delta^\bullet \in \text{Dc}^\bullet : \delta^\bullet \circ \flat \in \text{dc}(s)\}$ into the successor $\text{tr}(\delta^\bullet \circ \flat)(s)$ of s following the original decision $\delta^\bullet \circ \flat \in \text{Dc}$;
- the new $\text{GSL}[1\text{G}]$ formula is $\varphi^\bullet \triangleq \wp \prod_{x \in \text{rng}(\flat)}(x, x)\psi$.

Observe that, to normalize the game, we simply need to normalize its CGS, as well as to change the underlying $\text{GSL}[1\text{G}]$ formula, since agent and variable names now coincide. Indeed, the new $\text{GSL}[1\text{G}]$ formula differs from the original one only on its bindings, which now are all identities.

Example 4.2. Consider again the game depicted in Figure 2, with $\varphi = \wp \flat \text{Fp}$ a $\text{GSL}[1\text{G}]$ formula, where $\wp = \langle\langle x \geq 3 \rangle\rangle \llbracket y < 2 \rrbracket$ and $\flat = (\mathbf{a}, \mathbf{x})(\mathbf{b}, \mathbf{y})(\mathbf{c}, \mathbf{x})$. The resulting normalized CGS is $\mathcal{G}^\bullet \triangleq \langle \text{AP}, \text{Ag}^\bullet, \text{Ac}, \text{St}, \text{tr}^\bullet, \text{ap}, s_I \rangle$, where the set of new agents is $\text{Ag}^\bullet \triangleq \{x, y\}$ and the transition function is reported in Figure 3. Note that, the transitions in which the agents \mathbf{a} and \mathbf{c} in Figure 2 take different actions are removed. The associated $\text{GSL}[1\text{G}]$ sentence is $\varphi^\bullet \triangleq \langle\langle x \geq 3 \rangle\rangle \llbracket y < 2 \rrbracket (x, x)(y, y)\text{Fp}$.

4.2. Minimization

As for previous considerations, actions involving the same strategic reasoning need to be merged together. We accomplish this by constructing a new concurrent game structure that maintains just one representative for each class of equivalence actions. Before describing the formal construction, we need to introduce some accessory notions.

Given a CGS $\mathcal{G} = \langle \text{AP}, \text{Ag}, \text{Ac}, \text{St}, \text{tr}, \text{ap}, s_I \rangle$, one of its states $s \in \text{St}$, a quantification prefix $\wp \in \text{Qn}(\text{ag}(s))$, and a function $\text{vr} : \text{Qn} \rightarrow \text{Vr}$, we can define an equivalence relation $\delta_1 \equiv_s^\wp \delta_2$ between decisions $\delta_1, \delta_2 \in \text{Dc}$ with $\text{ag}(s) \setminus \text{vr}(\wp) \subseteq$

$\text{dom}(\delta_1), \text{dom}(\delta_2)$ that locally mimics the behavior of the one between assignments previously discussed. Intuitively, it allows to determine whether two different moves of a set of agents are actually mutually substitutable *w.r.t.* the strategy quantification of interest. Formally, we have that:

- 1) for the empty quantification prefix ϵ , it holds that $\delta_1 \equiv_s^\epsilon \delta_2$ iff $\text{tr}(\delta_1)(s) = \text{tr}(\delta_2)(s)$;
- 2) $\delta_1 \equiv_s^{\langle\langle a \geq g \rangle\rangle^\wp} \delta_2$ iff, for all active actions $c \in \text{ac}(s, a)$, it holds that $\delta_1[a \mapsto c] \equiv_s^\wp \delta_2[a \mapsto c]$;
- 3) $\delta_1 \equiv_s^{\llbracket a < g \rrbracket^\wp} \delta_2$ iff, for all indexes $i \in \{1, 2\}$ and active actions $c_i \in \text{ac}(s, a)$, there exists an active action $c_{3-i} \in \text{ac}(s, a)$ such that $\delta_1[a \mapsto c_1] \equiv_s^\wp \delta_2[a \mapsto c_2]$.

At this point, we can introduce an equivalence relation between the active actions $c_1, c_2 \in \text{ac}(s, a)$ of an agent $a \in \text{ag}(s)$, once a partial decision $\delta \in \text{Dc}$ with $\{a' \in \text{ag}(s) : a' <_\wp a\} \subseteq \text{dom}(\delta)$ of the agents already quantified is given. Formally, $c_1 \equiv_{s, \delta}^{\langle\langle a \geq g \rangle\rangle^\wp} c_2$ iff $\delta[a \mapsto c_1] \equiv_s^\wp \delta[a \mapsto c_2]$ and $c_1 \equiv_{s, \delta}^{\llbracket a < g \rrbracket^\wp} c_2$ iff $\delta[a \mapsto c_1] \equiv_s^{\bar{\wp}} \delta[a \mapsto c_2]$, where $\bar{\wp}$ represents the dual prefix of \wp , *i.e.*, $\bar{\wp} = \neg\wp$. Intuitively, the two actions c_1, c_2 are equivalent *w.r.t.* δ iff agent a can use them indifferently to extend δ , without changing the set of successors of s it can force to reach.

We can now introduce the concept of minimization of a CGS, in which the behavior of each agent is restricted in such a way that he can only choose the representative element from each class of equivalent actions. Before moving to the formal definition, as an additional notation, we use $\wp_{\geq a}$ to denote the suffix of the quantification prefix \wp starting from its variable/agent a .

Construction 4.2 (CGS Minimization). *From a CGS $\mathcal{G} = \langle \text{AP}, \text{Ag}, \text{Ac}, \text{St}, \text{tr}, \text{ap}, s_I \rangle$ normalized w.r.t. a binding prefix $\flat \in \text{Bn}(\text{Ag})$, and a quantification prefix $\wp \in \text{Qn}(\text{rng}(\flat))$, we build the minimized CGS $\mathcal{G}^\blacklozenge \triangleq \langle \text{AP}, \text{Ag}, \text{Ac}, \text{St}, \text{tr}^\blacklozenge, \text{ap}, s_I \rangle$, where the new transition function tr^\blacklozenge is defined as follows. First, assume $\Lambda(s, \delta, a) \subseteq \text{ac}(s, a)$ to be a subset of active actions for the agent $a \in \text{ag}(s)$ on the state $s \in \text{St}$ such that, for each $c \in \text{ac}(s, a)$, there is exactly one $c' \in \Lambda(s, \delta, a)$ with $c \equiv_{s, \delta}^{\wp_{\geq a}} c'$. Intuitively, $\Lambda(s, \delta, a)$ is one of the minimal sets of actions needed by the agent a in order to preserve the essential structure of the CGS. At this point, let $\text{dc}^\blacklozenge(s) \triangleq \{\delta \in \text{dc}(s) : \forall a \in \text{dom}(\delta). \delta(a) \in \Lambda(s, \delta_{\uparrow\{a' \in \text{dom}(\delta) : a' <_\wp a\}}, a)\}$ to be the set of active decisions having only values among those ones previously chosen. Finally, for each state $s \in \text{St}$ and decision $\delta \in \text{Dc}$, assume $\text{tr}^\blacklozenge(\delta)(s) \triangleq \text{tr}(\delta)(s)$, if $\delta \in \text{dc}^\blacklozenge(s)$, and $\text{tr}^\blacklozenge(\delta) \triangleq \emptyset$, otherwise.*

Observe that the minimization of the game only involves the CGS, as we just change the active actions of the agents, while states and agents remain unchanged.

Example 4.3. *Consider the normalized game \mathcal{G}^\bullet of the Example 4.2 and sentence $\wp^\bullet = \wp \flat \text{Fp}$, where $\wp = \langle\langle x \geq 3 \rangle\rangle \llbracket y < 2 \rrbracket$ and $\flat = (x, x)(y, y)$. The*

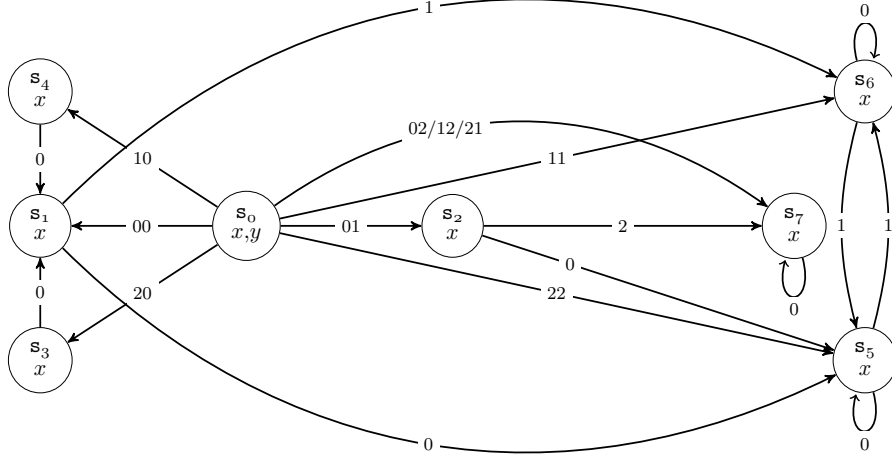

Figure 4: Minimized CGS \mathcal{G}^\diamond built on Normalized \mathcal{G}^\bullet .

corresponding minimized CGS is $\mathcal{G}^\diamond \triangleq \langle \text{AP}, \text{Ag}^\bullet, \text{Ac}, \text{St}, \text{tr}^\diamond, \text{ap}, s_I \rangle$, where the new transition function tr^\diamond is depicted in Figure 4. To give an intuition, we analyze the equivalence relation between the actions $0, 1 \in \text{ac}(s_3, x)$ of the agent x .

We have that $0 \equiv_{s_3, \emptyset}^{\epsilon} 1$ iff $\emptyset[x \mapsto 0] \equiv_{s_3}^{\llbracket y < 2 \rrbracket} \emptyset[x \mapsto 1]$ iff, for all indexes $i \in \{1, 2\}$ and active actions $c_i \in \text{ac}(s_3, y)$, there exists an active action $c_{3-i} \in \text{ac}(s_3, y)$ such that $\delta_1[y \mapsto c_1] \equiv_{s_3}^{\epsilon} \delta_2[y \mapsto c_2]$. Since $\text{ac}(s_3, y) = \emptyset$ the previous equivalence is vacuously verified. Therefore, 0 and 1 are equivalent actions.

4.3. Conversion

Finally, we describe the conversion of concurrent game structures into turn-based ones. As anticipated before, differently from similar transformations one can find in literature, the game we obtain is one with k agents and k variables, where k is the number of variables of the starting game. Additionally, our construction makes use of the concepts of minimization and equivalence between actions, by removing the ones that induce equivalent paths. The intuitive idea of our reduction is to replace each state in the concurrent game structure with a finite tree whose height depends on the number of strategy quantifications. Also, we enrich each state of the new structure with extra information regarding the corresponding state in the concurrent one: (i) the index of the operator in the prefix of quantifications; (ii) the sequence of actions taken by the agents along a partial play. The formal definition follows.

Construction 4.3 (CGS Conversion). *From a CGS $\mathcal{G} = \langle \text{AP}, \text{Ag}, \text{Ac}, \text{St}, \text{tr}, \text{ap}, s_I \rangle$ minimized w.r.t. a binding prefix $\flat \in \text{Bn}(\text{Ag})$ and a quantification prefix*

$\wp \in \text{Qn}(\text{rng}(b))$, we build the TBGS $\mathcal{G}^* \triangleq \langle \text{AP}, \text{Ag}, \text{Ac}, \text{St}^*, \text{tr}^*, \text{ap}^*, s_I^* \rangle$, where the new set of states St^* and the new transition function tr^* are defined as follows. Given a state $s \in \text{St}$, we denote by \wp^s the quantification prefix obtained from \wp by simply deleting all agents/variables not in $\text{ag}(s)$ and by $\text{Vr}(\wp^s)$ the corresponding set of variables. The state space has to maintain the information about the position in \mathcal{G} together with the index of the first variable that has still to be evaluated and the values already associated to the previous variables. To do this, we set $\text{St}^* \triangleq \{(s, i, \delta) \mid s \in \text{St}, i \in [0, |\text{ag}(s)|], \delta \in (\text{Vr}(\wp_{<i}^s) \rightarrow \text{Ac})\}$. Observe that, when a play is in a state $(s, |\text{ag}(s)|, \delta)$, all quantifications are already resolved and it is time to evaluate the corresponding decision δ . Before proceeding with the definition of the transition function, it is helpful to identify which are the active agents and decisions for each possible state. Formally, for all $(s, i, \delta) \in \text{St}^*$, we have that $\text{ag}((s, i, \delta)) \triangleq \{\text{vr}(\wp_i^s)\}$ and $\text{dc}^*((s, i, \delta)) \triangleq \{\text{vr}(\wp_i^s) \mapsto c : c \in \text{ac}(s, \text{vr}(\wp_i^s))\}$, if $i < |\wp^s|$, and $\text{ag}((s, i, \delta)) \triangleq \emptyset$ and $\text{dc}^*((s, i, \delta)) \triangleq \{\emptyset\}$, otherwise. The transition function is defined as follows. For each new state (s, i, δ) with $i < |\wp^s|$ and new decision $\text{vr}(\wp_i^s) \mapsto c$, we simply need to increase the counter i and embed $\text{vr}(\wp_i^s) \mapsto c$ into δ . Formally, we set $\text{tr}^*(\text{vr}(\wp_i^s) \mapsto c)((s, i, \delta)) \triangleq (s, i+1, \delta[\text{vr}(\wp_i^s) \mapsto c])$. For a new state $(s, |\text{ag}(s)|, \delta)$, instead, we just introduce a transition to the state $(s', 0, \emptyset)$, where s' is the successor of s in the CGS following the decision δ . Formally, we have $\text{tr}^*(\emptyset)((s, |\text{ag}(s)|, \delta)) \triangleq (\text{tr}(\delta)(s), 0, \emptyset)$. The new labeling function ap^* is such that, for each state (s, j, δ) we have that

$$\text{ap}^*((s, j, \delta)) \triangleq \begin{cases} \text{ap}(s), & \text{if } j = 0 \text{ and } \delta = \emptyset; \\ \emptyset, & \text{otherwise.} \end{cases}$$

Finally, the initial state $s_I^* \triangleq (s_I, 0, \emptyset)$.

By means of a simple generalization of the classic correctness proof of a transformation of a concurrent game into a turn-based one, the following result derives.

Theorem 4.1 (Concurrent/Turn-Based Conversion). *For each CGS \mathcal{G} with $|\text{St}|$ and GSL[1G] formula $\varphi = \wp b \psi$ with $|\text{Vr}(\wp)|$ variables, there is an equivalent TBGS \mathcal{G}^* with $|\text{Vr}(\wp)|$ agents/variables of order $O(|\text{St}| \cdot |\text{Ac}|^{|\text{Vr}(\wp)|})$.*

Proof. The theorem is proved by following the three steps of *normalization*, *minimization* and *conversion*. In detail, from a CGS $\mathcal{G} = \langle \text{AP}, \text{Ag}, \text{Ac}, \text{St}, \text{tr}, \text{ap}, s_I \rangle$, a binding prefix $b \in \text{Bn}(\text{Ag})$ and GSL[1G] formula $\varphi = \wp b \psi$, by applying the construction described in Sections 4.1, we obtain the *normalized* CGS $\mathcal{G}^\bullet \triangleq \langle \text{AP}, \text{Ag}^\bullet, \text{Ac}, \text{St}, \text{tr}^\bullet, \text{ap}, s_I \rangle$. At this point, From the latter *w.r.t.* a binding prefix $\flat \in \text{Bn}(\text{Ag})$, and a quantification prefix $\wp \in \text{Qn}(\text{rng}(b))$, by applying the construction described in Sections 4.2 we build the *minimized* CGS $\mathcal{G}^\blacklozenge \triangleq \langle \text{AP}, \text{Ag}, \text{Ac}, \text{St}, \text{tr}^\blacklozenge, \text{ap}, s_I \rangle$. Finally, , we build the TBGS $\mathcal{G}^* \triangleq \langle \text{AP}, \text{Ag}, \text{Ac}, \text{St}^*, \text{tr}^*, \text{ap}^*, s_I^* \rangle$ by applying the construction in Sections 4.3 to the minimized CGS $\mathcal{G}^\blacklozenge \triangleq \langle \text{AP}, \text{Ag}, \text{Ac}, \text{St}, \text{tr}^\blacklozenge, \text{ap}, s_I \rangle$. Regarding the complexity of the conversion from \mathcal{G} to \mathcal{G}^* , we have that the size of \mathcal{G}^* is exponential in the number of the variable of the quantification prefix. Indeed, for each $s \in \text{St}$, the

conversion produces a number of states equal to $\sum_{i=0}^{|\text{ag}(s)|} |\text{Ac}|^i = O(|\text{Ac}|^{|\text{ag}(s)|})$. So, the overall size is $O(|\text{St}| \cdot |\text{Ac}|^{|\text{ag}(s)|})$. Thanks to the normalization $\text{Ag} = \text{Vr}(\wp)$, the result follows. \square

Example 4.4. Consider the minimized game $\mathcal{G}^\blacklozenge$ of Example 4.3 with the formula $\varphi^\blacklozenge = \varphi^\bullet$. We want to build a turn-based game \mathcal{G}^* from $\mathcal{G}^\blacklozenge$. The new CGS is $\mathcal{G}^* \triangleq \langle \text{AP}, \text{Ag}^\bullet, \text{Ac}, \text{St}^*, \text{tr}^*, \text{ap}^*, s_I^* \rangle$, where the new set of states St^* , the new transition function tr^* , and the new initial state $s_I^* \triangleq (s_0, 0, \emptyset)$ are depicted in Figure 5. Finally, the labeling function is $\text{ap}(s_0, 0, \emptyset) = \text{ap}(s_2, 0, \emptyset) = \text{ap}(s_3, 0, \emptyset) = \text{ap}(s_4, 0, \emptyset) = \text{ap}(s_7, 0, \emptyset) = p$ and, for each state (s, j, δ) , with $j \neq 0$ and $\delta \neq \emptyset$ we have that $\text{ap}(s, j, \delta) = \emptyset$.

5. Determinacy

In this section, we address the determinacy problem for a fragment of GSL, that we name $\text{GSL}[1\text{G}, 2\text{AG}]$, involving only two players over turn-based structures. Recall that determinacy has been first proved for classic Borel turn-based two-player games in [38]. However, the proof used there does not directly apply to our graded setting. To give evidence of the differences between the two frameworks, observe that in $\text{SL}[1\text{G}, 2\text{AG}]$ sentences like $\langle\langle x \rangle\rangle[\langle\bar{x}\rangle]\eta$ imply $[\langle\bar{x}\rangle]\langle\langle x \rangle\rangle\eta$, while in $\text{GSL}[1\text{G}, 2\text{AG}]$ the corresponding implication $\langle\langle x \geq i \rangle\rangle[\langle\bar{x} < j \rangle]\eta \Rightarrow [\langle\bar{x} < j \rangle]\langle\langle x \geq i \rangle\rangle\eta$ does not hold. The determinacy property we are interested in is exactly the converse direction, *i.e.*, $[\langle\bar{x} < j \rangle]\langle\langle x \geq i \rangle\rangle\eta \Rightarrow \langle\langle x \geq i \rangle\rangle[\langle\bar{x} < j \rangle]\eta$. In particular, we extend the Gale-Stewart Theorem [39], by exploiting a deep generalization of the technique used in [31]. The idea consists of a fixed-point calculation over the number of winning strategies an agent can select against all but a fixed number of those of its opponent. Regarding this approach, we recall that the simpler counting considered in [31] is restricted to existential quantifications only.

Construction 5.1 (Grading Function). Let \mathcal{G} be a two-agent turn-based game structure \mathcal{G} with $\text{Ag} = \{\alpha, \bar{\alpha}\}$, and ψ be an LTL formula with $W_\psi, W_{\neg\psi} \subseteq \text{Hst}$ denoting the witness sets for ψ and $\neg\psi$, respectively. It is immediate to see that, in case $s_I \in W_\psi$ (*resp.*, $s_I \in W_{\neg\psi}$), all strategy profiles are equivalent w.r.t. the temporal property ψ (*resp.*, $\neg\psi$). If $s_I \in X \triangleq \text{Hst} \setminus (W_\psi \cup W_{\neg\psi})$, instead, we need to introduce a grading function $G_\psi^\alpha : X \rightarrow \Gamma$, where $\Gamma \triangleq \mathbb{N} \rightarrow (\mathbb{N} \cup \{\omega\})$, that allows to determine how many different strategies the agent α (*resp.*, $\bar{\alpha}$) owns w.r.t. ψ (*resp.*, $\neg\psi$). Informally, $G_\psi^\alpha(\rho)(j)$ represents the number of winning strategies player α can put up against all but at most j strategies of its adversary $\bar{\alpha}$, once the current play has already reached the history $\rho \in X$.

Before continuing, observe that α sometimes has the possibility to commit a suicide, *i.e.*, to choose a strategy leading directly to a history in $W_{\neg\psi}$, with the hope to win the game by collapsing all strategies of its opponent into a unique class. The set of histories enabling this possibility is defined as follows: $S \triangleq \{\rho \in X : \exists \rho' \in W_{\neg\psi} . \rho < \rho' \wedge \forall \rho'' \in \text{Hst} . \rho \leq \rho'' < \rho' \Rightarrow \rho'' \in \text{Hst}_\alpha\}$, where $\text{Hst}_\alpha = \{\rho \in \text{Hst} : \text{ag}(\text{lst}(\rho)) = \{\alpha\}\}$ is the set of histories ending in a state controlled by α . Intuitively, α can autonomously extend a history $\rho \in S$ into one

$\rho' \in W_{\neg\psi}$ that is surely loosing, independently of the behavior of $\bar{\alpha}$. Note that there may be several suicide strategies, but all of them are equivalent w.r.t. the property ψ . Also, against them, all counter strategies of $\bar{\alpha}$ are equivalent as well.

At this point, to define the function G_ψ^α , we introduce the auxiliary functor $F_\psi^\alpha : (X \rightarrow \Gamma) \rightarrow (X \rightarrow \Gamma)$, whose least fixpoint represents a function returning the maximum number of different strategies α can use against all but a precise fixed number of counter strategies of $\bar{\alpha}$. Formally, we have that:

$$F_\psi^\alpha(f)(\rho)(j) \triangleq \begin{cases} \sum_{\rho' \in \text{suc}(\rho) \cap X} f(\rho')(0) + |\text{suc}(\rho) \cap W_\psi|, & \text{if } \rho \in \text{Hst}_\alpha \text{ and } j = 0; \\ \sum_{\rho' \in \text{suc}(\rho) \cap X} f(\rho')(j), & \text{if } \rho \in \text{Hst}_\alpha \text{ and } j > 0; \\ \sum_{c \in C(\rho)(j)} \prod_{\rho' \in \text{dom}(c)} f(\rho')(c(\rho')), & \text{otherwise;} \end{cases}$$

where $\text{suc}(\rho) = \{\rho' \in \text{Hst} : \exists s \in \text{St}. \rho s = \rho'\}$ and $C(\rho)(i) \subseteq (\text{suc}(\rho) \cap X) \rightarrow \mathbb{N}$ contains all partial functions $c \in C(\rho)(i)$ for which α owns a suicide strategy on the histories not in their domains, i.e., $(\text{suc}(\rho) \cap X) \setminus \text{dom}(c) \subseteq S$, and the sum of all values assumed by c plus the number of successor histories that are neither surely winning nor contained in the domain of c equals to i , i.e., $i = \sum_{\rho' \in \text{dom}(c)} c(\rho') + |\text{suc}(\rho) \setminus (W_\psi \cup \text{dom}(c))|$.

Intuitively, the first item of the definition simply asserts that the number of strategies $F(f)(\rho)(0)$ that agent α has on the α -history ρ , without excluding any counter strategy of its adversary, is obtainable as the sum of the $f(\rho')(0)$ strategies on the successor histories $\rho' \in X$ plus a single strategy for each successor history that is surely winning. Similarly, the second item takes into account the case in which we can avoid exactly j counter strategies. The last item, instead, computes the number of strategies for α on the $\bar{\alpha}$ -histories. In particular, through the set $C(\rho)(j)$, it first determines in how many ways it is possible to split the number j of counter strategies to avoid among all successor histories of ρ . Then, for each of these splittings, it calculates the product of the corresponding numbers $f(\rho')(c(\rho'))$ of strategies for α .

We are finally able to define the grading function G_ψ^α by means of the least fixpoint $f^* = F_\psi^\alpha(f^*)$ of the functor F_ψ^α , whose existence is proved in Lemma 5.1:

$$G_\psi^\alpha(\rho)(j) \triangleq \sum_{h=0}^j f^*(\rho)(h) + \begin{cases} 1, & \text{if } \rho \in S \text{ and } j \geq 1; \\ 0, & \text{otherwise.} \end{cases}$$

Intuitively, $G_\psi^\alpha(\rho)(j)$ is the sum of the numbers $f^*(\rho)(h)$ of winning strategies the agent α can exploit against all but exactly h strategies of its adversary $\bar{\alpha}$, for each $h \in [0, j]$. Moreover, if $\rho \in S$, we need to add to this counting the suicide strategy that α can use once $\bar{\alpha}$ avoids to apply his unique counter strategy.

Lemma 5.1 (Fixpoint Existence). *The functor F_ψ^α of Construction 5.1 admits a unique least-fixed point.*

Proof. Consider the set of functions $D \triangleq X \rightarrow \Gamma$, where $\Gamma \triangleq \mathbb{N} \rightarrow (\mathbb{N} \cup \{\omega\})$, equipped with the binary relation $\sqsubseteq \subseteq D \times D$ defined as follows: $f_1 \sqsubseteq f_2$ iff

$f_1(\rho)(j) \leq f_2(\rho)(j)$, for all histories $\rho \in X$ and indexes $j \in \mathbb{N}$, where \leq is the standard ordering on the set of natural numbers extended with the maximum element ω . Now, it is immediate to see that \sqsubseteq is a reflexive, antisymmetric, and transitive relation over D . Hence, (D, \sqsubseteq) is a partial order. Actually, this structure is a complete lattice [40], since any set of functions $F \subseteq D$ admits a greatest lower bound $\inf F$, which can be computed as follows: $(\inf F)(\rho)(j) \triangleq \min_{f \in F} f(\rho)(j)$, for all $\rho \in X$ and $j \in \mathbb{N}$. Moreover, by direct inspection, it can be easily showed that the functor $F_\psi^\alpha : D \rightarrow D$ over D defined in Construction 5.1 is monotone *w.r.t.* \sqsubseteq , *i.e.*, $F_\psi^\alpha(f_1) \sqsubseteq F_\psi^\alpha(f_2)$, whenever $f_1 \sqsubseteq f_2$, for all $f_1, f_2 \in D$ (in particular, notice that the only operations used in its definition are the sum and the multiplication). Consequently, by the Knaster-Tarski Theorem, F_ψ^α admits a least fixpoint. \square

Thanks to the above construction, one can compute the maximum number of strategies that a player has at its disposal against all but a fixed number of strategies of the opponent. Next lemma precisely describes this fact. Indeed, we show how the satisfiability of a $\text{GSL}[1G, 2AG]$ sentence $\langle\langle x \geq i \rangle\rangle[\bar{x} \leq j](\alpha, x)(\bar{\alpha}, \bar{x})\psi$ can be decided via the computation of the associated grading function G_ψ^α , where by $[\bar{x} \leq j]\varphi$ we mean $[\bar{x} < j + 1]\varphi$.

Lemma 5.2 (Grading Function). *Let \mathcal{G} be a two-agent turn-based game structure, where $\text{Ag} = \{\alpha, \bar{\alpha}\}$, and $\varphi = \langle\langle x \geq i \rangle\rangle[\bar{x} \leq j](\alpha, x)(\bar{\alpha}, \bar{x})\psi$ a $\text{GSL}[1G, 2AG]$ sentence. Moreover, let G_ψ^α be the grading function and $W_\psi, W_{\neg\psi}, X \subseteq \text{Hst}$ the sets of histories obtained in Construction 5.1. Then, $\mathcal{G} \models \varphi$ iff one of the following three conditions hold: (i) $i \leq 1$, $j \geq 0$, and $s_I \in W_\psi$; (ii) $i \leq 1$, $j \geq 1$, and $s_I \in W_{\neg\psi}$; (iii) $i \leq G_\psi^\alpha(s_I)(j)$ and $s_I \in X$.*

Proof. For the case (i), we consider the worst scenario in which $i = 1$ and $j = 0$, *i.e.*, we have the sentence $\varphi = \langle\langle x \geq 1 \rangle\rangle[\bar{x} \leq 0](\alpha, x)(\bar{\alpha}, \bar{x})\psi$. Since $s_I \in W_\psi$ and W_ψ only contains histories that cannot be extended to a play violating the property ψ , we know that from s_I , by taking any strategy for player α against all strategies for the player $\bar{\alpha}$, the corresponding play satisfy the formula ψ . Moreover, all strategies are equivalent. We show this by directly analyzing the semantic of sentence φ .

1. $\mathcal{G} \models \varphi$ iff $|(\{\emptyset[x \mapsto \sigma_x] : \sigma_x \in \varphi'[\mathcal{G}, \emptyset, s_I](x)\} / \equiv_{\mathcal{G}}^{\varphi'})| \geq 1$, where $\varphi' = [\bar{x} \leq 0](\alpha, x)(\bar{\alpha}, \bar{x})\psi$;
2. $\varphi'[\mathcal{G}, \emptyset, s_I](x) = \{\sigma_x \in \text{Str}(\{\alpha\}) : \mathcal{G}, \emptyset[x \mapsto \sigma_x], s_I \models \varphi'\}$;
3. $\mathcal{G}, \emptyset[x \mapsto \sigma_x], s_I \models \varphi'$ iff $|(\{\emptyset[x \mapsto \sigma_x, \bar{x} \mapsto \sigma_{\bar{x}}] : \sigma_{\bar{x}} \in \neg\varphi''[\mathcal{G}, \emptyset[x \mapsto \sigma_x], s_I](\bar{x})\} / \equiv_{\mathcal{G}}^{\neg\varphi''})| \leq 0$, where $\varphi'' = (\alpha, x)(\bar{\alpha}, \bar{x})\psi$;
4. $\neg\varphi''[\mathcal{G}, \emptyset[x \mapsto \sigma_x], s_I](\bar{x}) = \{\sigma_{\bar{x}} \in \text{Str}(\{\bar{\alpha}\}) : \mathcal{G}, \emptyset[x \mapsto \sigma_x, \bar{x} \mapsto \sigma_{\bar{x}}], s_I \models \neg\varphi''\}$;
5. $\mathcal{G}, \emptyset[x \mapsto \sigma_x, \bar{x} \mapsto \sigma_{\bar{x}}], s_I \not\models \neg\varphi''$, since $\mathcal{G}, \emptyset[x \mapsto \sigma_x, \bar{x} \mapsto \sigma_{\bar{x}}], s_I \models \varphi''$ due to the fact that $s_I \in W_\psi$.

By item (5), the set $\neg\varphi''[\mathcal{G}, \emptyset[x \mapsto \sigma_x], s_I](\bar{x})$ of item (4) is empty. Therefore, from the item (3) we immediately derive that $\mathcal{G}, \emptyset[x \mapsto \sigma_x], s_I \models \varphi'$. Consequently, the

set $\varphi'[\mathcal{G}, \emptyset, s_I](x)$ of item (2) is equal to $\text{Str}(\{\alpha\})$, from which we immediately see at item (1) that $\mathcal{G}, \emptyset, s_I \models \varphi$.

For the case (ii), we consider the worst scenario in which $i = 1$ and $j = 1$, *i.e.* we have the sentence $\varphi = \langle\langle x \geq 1 \rangle\rangle[\langle\langle \bar{x} \leq 1 \rangle\rangle](\alpha, x)(\bar{\alpha}, \bar{x})\psi$. Since $s_I \in W_{\neg\psi}$ then the player $\bar{\alpha}$ can use all its strategies to satisfy $\neg\psi$, independently from behavior of α . By Definition 3.3, we know that all these strategies are equivalent. Therefore, by removing the unique corresponding equivalence class we have that agent α can use any of its strategies to vacuously satisfy the formula ψ , since we do not actually require φ to hold at all. Also in this case, we show this by directly analyzing the semantic of sentence φ .

1. $\mathcal{G} \models \varphi$ iff $|(\{\emptyset[x \mapsto \sigma_x] : \sigma_x \in \varphi'[\mathcal{G}, \emptyset, s_I](x)\} / \equiv_{\mathcal{G}}^{\varphi'})| \geq 1$, where $\varphi' = \langle\langle \bar{x} \leq 0 \rangle\rangle(\alpha, x)(\bar{\alpha}, \bar{x})\psi$;
2. $\varphi'[\mathcal{G}, \emptyset, s_I](x) = \{\sigma_x \in \text{Str}(\{\alpha\}) : \mathcal{G}, \emptyset[x \mapsto \sigma_x], s_I \models \varphi'\}$;
3. $\mathcal{G}, \emptyset[x \mapsto \sigma_x], s_I \models \varphi'$ iff $|(\{\emptyset[x \mapsto \sigma_x, \bar{x} \mapsto \sigma_{\bar{x}}] : \sigma_{\bar{x}} \in \neg\varphi''[\mathcal{G}, \emptyset[x \mapsto \sigma_x], s_I](\bar{x})\} / \equiv_{\mathcal{G}}^{\neg\varphi''})| \leq 1$, where $\varphi'' = (\alpha, x)(\bar{\alpha}, \bar{x})\psi$;
4. $\neg\varphi''[\mathcal{G}, \emptyset[x \mapsto \sigma_x], s_I](\bar{x}) = \{\sigma_{\bar{x}} \in \text{Str}(\{\bar{\alpha}\}) : \mathcal{G}, \emptyset[x \mapsto \sigma_x, \bar{x} \mapsto \sigma_{\bar{x}}], s_I \models \neg\varphi''\}$;
5. $\mathcal{G}, \emptyset[x \mapsto \sigma_x, \bar{x} \mapsto \sigma_{\bar{x}}], s_I \models \neg\varphi''$, since $s_I \in W_{\neg\psi}$.

By item (5), the set $\neg\varphi''[\mathcal{G}, \emptyset[x \mapsto \sigma_x], s_I](\bar{x})$ of item (4) is equal to $\text{Str}(\{\bar{\alpha}\})$. By Definition 3.3, for all $\sigma_1, \sigma_2 \in \neg\varphi''[\mathcal{G}, \emptyset[x \mapsto \sigma_x], s_I](\bar{x})$, it holds that $\emptyset[x \mapsto \sigma_x, \bar{x} \mapsto \sigma_1] \equiv_{\mathcal{G}}^{\neg\varphi''} \emptyset[x \mapsto \sigma_x, \bar{x} \mapsto \sigma_2]$. Due to this fact, $|(\{\emptyset[x \mapsto \sigma_x, \bar{x} \mapsto \sigma_{\bar{x}}] : \sigma_{\bar{x}} \in \neg\varphi''[\mathcal{G}, \emptyset[x \mapsto \sigma_x], s_I](\bar{x})\} / \equiv_{\mathcal{G}}^{\neg\varphi''})| = 1$ we immediately derive that $\mathcal{G}, \emptyset[x \mapsto \sigma_x], s_I \models \varphi'$. Consequently, the set $\varphi'[\mathcal{G}, \emptyset, s_I](x)$ of item (2) is equal to $\text{Str}(\{\alpha\})$, from which we immediately see at item (1) that $\mathcal{G}, \emptyset, s_I \models \varphi$.

For the case (iii), the proof proceeds by *nested induction* over the indexes j and i of strategy counting. Precisely, the external induction is done over j , while the internal one over i .

As internal base case, *i.e.*, when $j = 0$ and $i = 1$, we have that $\mathbf{G}_{\psi}^{\alpha}(s_I)(0) \triangleq \mathbf{f}^*(s_I)(0) \geq 1$, where \mathbf{f}^* is the least fix point of the functor $\mathbf{F}_{\psi}^{\alpha}$, *i.e.*, $\mathbf{f}^* = \mathbf{F}_{\psi}^{\alpha}(\mathbf{f}^*)$. Now, let $\sigma_{\alpha} \in \text{Str}(\{\alpha\})$ be an α -strategy satisfying the following property: for all histories $\rho \in X \cap \text{Hst}_{\alpha}$ with $\mathbf{f}^*(\rho)(0) \geq 1$, if $\text{suc}(\rho) \cap W_{\psi} \neq \emptyset$, then the action $\sigma_{\alpha}(\rho)$ is chosen in such a way that the successor history $\rho' \triangleq \rho \cdot \text{tr}(\{\alpha \mapsto \sigma_{\alpha}(\rho)\})(\text{lst}(\rho))$ of ρ following the decision $\{\alpha \mapsto \sigma_{\alpha}(\rho)\}$ belongs to $\text{suc}(\rho) \cap W_{\psi}$, *i.e.*, $\rho' \in \text{suc}(\rho) \cap W_{\psi}$. Otherwise, we require that $\mathbf{f}^*(\rho')(0) \geq 1$. The existence of such a strategy is immediately derived by the first case of the definition of the functor $\mathbf{F}_{\psi}^{\alpha}$. Moreover, σ_{α} is a winning strategy for α , due to the last case of the same definition. To see that this is actually the case, let $\sigma_{\bar{\alpha}} \in \text{Str}(\{\bar{\alpha}\})$ be an $\bar{\alpha}$ -strategy and consider the resulting play $\pi = \text{play}(\{\alpha \mapsto \sigma_{\alpha}, \bar{\alpha} \mapsto \sigma_{\bar{\alpha}}\}, s_I)$. Due to the construction of σ_{α} , on every history $\rho \in \text{Hst}_{\alpha}$ that is a prefix of π , we have that $\mathbf{f}^*(\rho)(0) \geq 1$. The same holds for every $\rho \in \text{Hst}_{\bar{\alpha}}$ that is a prefix of π , as well. Indeed, due to the last case of the definition of the functor, we would have had $\mathbf{f}^*(\rho')(0) = 0$ otherwise, for all histories $\rho' \leq \rho$. However, this is clearly impossible, due to the fact that $\mathbf{f}^*(s_I)(0) \geq 1$. Now, since \mathbf{f}^* is the least

fix point of F_ψ^α , there exists necessarily a prefix $\rho \in \text{Hst}$ of π belonging to W_ψ , which implies that π satisfies the temporal property ψ .

For the internal inductive case, *i.e.*, when $j = 0$ and $i > 1$, assume S_α to be the set of $i - 1$ non-equivalent winning α -strategies constructed by inductive hypothesis. We want to prove that there exists a new α -strategy $\sigma_\alpha \in \text{Str}(\{\alpha\})$ that is neither contained in S_α nor equivalent to any of those strategies there contained. To do this, let σ_α be the strategy satisfying the following property: for all histories $\rho \in X \cap \text{Hst}_\alpha$ with $\rho' \triangleq \rho \cdot \text{tr}(\{\alpha \mapsto \sigma_\alpha(\rho)\})(\text{lst}(\rho))$, it holds that $|\{\sigma \in S_\alpha : \rho' = \rho \cdot \text{tr}(\{\alpha \mapsto \sigma(\rho)\})(\text{lst}(\rho))\}| < f^*(\rho')(0)$. Intuitively, the actions prescribed by σ_α force a play to follow histories that are not completely covered by the other strategies. Therefore, if such a strategy σ_α exists, we necessarily have that $\sigma_\alpha \notin S_\alpha$. Moreover, due to the turn-based structure of the underlying model, this observation also suffices to prove that σ_α cannot be equivalent to any strategy contained in S_α . Indeed, due to the particular choice of the actions $\sigma_\alpha(\rho)$, there exists a play compatible with σ_α that is not compatible with any other strategy of this predetermined set. If, instead, such a particular strategy does not exist, there is a history $\rho \in X \cap \text{Hst}_{\bar{\alpha}}$ ruled by the opponent player $\bar{\alpha}$ satisfying the following: (i) for all prefixes $\rho' < \rho$, it holds that $\rho' \in \text{Hst}_\alpha$; (ii) $|\{\sigma \in S_\alpha : \forall \rho' < \rho. \rho' \cdot \text{tr}(\{\alpha \mapsto \sigma(\rho')\})(\text{lst}(\rho')) \leq \rho\}| < f^*(\rho)(0)$. Intuitively, these two properties ensure that the number of strategies of S_α passing through ρ is strictly less than the one predicted by the function f^* . Consequently, there is an α -strategy $\sigma_\alpha \notin S_\alpha$ such that $\rho' \cdot \text{tr}(\{\alpha \mapsto \sigma_\alpha(\rho')\})(\text{lst}(\rho')) \leq \rho$, for all $\rho' < \rho$. Also in this case σ_α is not equivalent to any strategy in S_α . Indeed, due to property (ii), there always exists an $\bar{\alpha}$ -strategy that forces σ_α and $\sigma \in S_\alpha$ to follow different and, so, non equivalent plays. To conclude this case, one has to prove that σ_α is winning. To do this, the same approach used in the base case above can be applied.

Finally, for the remaining two cases having $j > 0$, we proceed similarly to the previous ones, by taking additional care to eliminate j strategies of player $\bar{\alpha}$ while proving that the considered i strategies of player α are winning. This is done by exploiting the splitting of all the $\bar{\alpha}$ -strategies dictated by the set $C(\rho)(j)$ used in the last case of the definition of the functor F_ψ^α . \square

By transfinite induction on its recursive structure, we can prove a quite natural but fundamental property of the grading function, *i.e.*, its duality in the form described in the next lemma. To give an intuition, assume that agent $\bar{\alpha}$ has at most j strategies to satisfy the temporal property $\neg\psi$ against all but at most i strategies of its adversary α . Then, it can be shown that the latter has more than i strategies to satisfy ψ against all but at most j strategies of the former.

Lemma 5.3 (Grading Duality). *Let G_ψ^α and $G_{\neg\psi}^{\bar{\alpha}}$ be the grading functions and $X \subseteq \text{Hst}$ the set of histories obtainable by Construction 5.1. For all histories $\rho \in X$ and indexes $i, j \in \mathbb{N}$, it holds that if $G_{\neg\psi}^{\bar{\alpha}}(\rho)(i) \leq j$ then $i < G_\psi^\alpha(\rho)(j)$.*

Summing up the above two results, we can easily prove that, on turn-based game structures, $\text{GSL}[1G, 2AG]$ is determined. Indeed, suppose that $s_I \in X$ and $\mathcal{G} \models \llbracket \bar{x} \leq j \rrbracket \langle\langle x \geq i \rangle\rangle b\psi$, where $b = (\alpha, x)(\bar{\alpha}, \bar{x})$ (the case with $s_I \in$

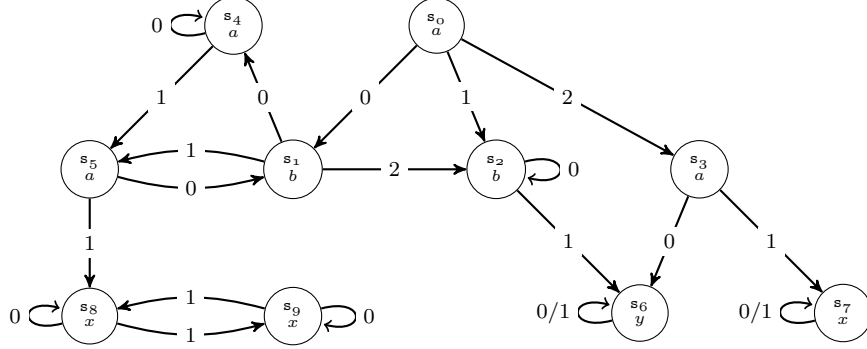

Figure 6: Turn-based structure.

W_ψ immediately follows from classic Martin's Determinacy Theorem [38, 41]). Obviously, \mathcal{G} does not satisfy the negation of this sentence, *i.e.*, $\mathcal{G} \not\models \langle\langle \bar{x} \geq j+1 \rangle\rangle \llbracket x \leq i-1 \rrbracket \mathfrak{b} \neg \psi$. By Lemma 5.2, we have that $G_{\neg\psi}^\alpha(s_I)(i-1) \leq j$. Hence, by Lemma 5.3, it follows that $i \leq G_\psi^\alpha(s_I)(j)$. Finally, again by Lemma 5.2, we obtain that $\mathcal{G} \models \langle\langle x \geq i \rangle\rangle \llbracket \bar{x} \leq j \rrbracket \mathfrak{b} \psi$, as required by the definition of determinacy.

Theorem 5.1 (Determinacy). *GSL[1G, 2AG] on turn-based game structures is determined.*

Example 5.1. *Consider the structure depicted in Figure 6, the state $s_0 \in \text{St}$, and the formula $\varphi = \langle\langle x \leq g_1 \rangle\rangle \llbracket y < g_2 \rrbracket \mathfrak{b} \psi$, with $\mathfrak{b} = (a, x)(b, y)$ and $\psi = \text{Fp}$. The set of histories W_ψ is $s_0 \cdot s_3 \cdot s_7^+ + s_0 \cdot (s_1 \cdot s_5)^+ \cdot s_8^+ \cdot s_9 \cdot (s_8 + s_9)^* + s_0 \cdot s_1 \cdot ((s_5 \cdot s_1)^* \cdot s_4)^+ \cdot (\epsilon + s_5 + s_5 \cdot (s_1 + s_8 \cdot (s_8 + s_9)^*))$, while $W_{\neg\psi} \triangleq s_0 \cdot (s_2^+ \cdot s_6^* + s_3 \cdot s_6^+)$. The set X contains $s_0 + s_0 \cdot s_3 + s_0 \cdot (s_1 \cdot s_5)^* \cdot s_1 + s_0 \cdot (s_1 \cdot s_5)^+ + s_0 \cdot (s_1 \cdot s_5)^+ \cdot s_8^+$. Finally, the set of suicide strategies is $s_0 + s_0 \cdot s_3$.*

Now, we evaluate the results of function \mathfrak{f} for each history in X . First, we set $\mathfrak{f}_0(\rho)(j) = 0, \forall \rho \in \text{Hst}$ and $\forall j \geq 0$. For all $k > 0, i \geq 0$, and the history $s_0 s_3$, we have that

$$\mathfrak{f}_k(s_0 s_3)(i) \triangleq \begin{cases} 0, & \text{if } i > 0; \\ 1, & \text{otherwise.} \end{cases}$$

For all $k > 0, i \geq 0$, and $\rho \in s_0 \cdot (s_1 \cdot s_5)^+ \cdot s_8^+$, we have that

$$\mathfrak{f}_k(\rho)(i) \triangleq \begin{cases} 0, & \text{if } i > 0; \\ k, & \text{otherwise.} \end{cases}$$

For all $k > 0, i \geq 0$, and $\rho \in s_0 \cdot (s_1 \cdot s_5)^+$, we have that

$$\mathfrak{f}_k(\rho)(i) \triangleq \begin{cases} 0, & \text{if } k < (2i) + 1; \\ k - ((2i) + 1), & \text{otherwise.} \end{cases}$$

For all $k > 0$, $i \geq 0$, and $\rho \in s_0 \cdot (s_1 \cdot s_5)^* \cdot s_1$, we have that

$$f_k(\rho)(i) \triangleq \begin{cases} 0, & \text{if } k < (2i) \text{ or } i = 0; \\ k - (2i), & \text{otherwise.} \end{cases}$$

For all $k > 0$, $i \geq 0$, and the history s_0 , we have that

$$f_k(s_0)(i) \triangleq \begin{cases} 0, & \text{if } k < (2i) + 1 \text{ and } i > 0 \text{ or } k < 2 \text{ and } i = 0; \\ 1, & \text{if } k \geq 2 \text{ and } i = 0; \\ k - ((2i) + 1), & \text{otherwise.} \end{cases}$$

Now, we illustrate the results of fixpoint f^* . For all $i \geq 0$ and the history $s_0 s_3$, we have that

$$f^*(s_0 s_3)(i) \triangleq \begin{cases} 0, & \text{if } i > 0; \\ 1, & \text{otherwise.} \end{cases}$$

For all $i \geq 0$ and $\rho \in s_0 \cdot (s_1 \cdot s_5)^+ \cdot s_8^+$, we have that

$$f^*(\rho)(i) \triangleq \begin{cases} 0, & \text{if } i > 0; \\ \omega, & \text{otherwise.} \end{cases}$$

For all $i \geq 0$ and $\rho \in s_0 \cdot (s_1 \cdot s_5)^+$, we have that

$$f^*(\rho)(i) \triangleq \omega$$

For all $i \geq 0$ and $\rho \in s_0 \cdot (s_1 \cdot s_5)^* \cdot s_1$, we have that

$$f^*(\rho)(i) \triangleq \begin{cases} 0, & \text{if } i = 0; \\ \omega, & \text{otherwise.} \end{cases}$$

For all $k > 0$, $i \geq 0$, and history the s_0 , we have that

$$f^*(s_0)(i) \triangleq \begin{cases} 1, & \text{if } i = 0; \\ \omega, & \text{otherwise.} \end{cases}$$

Finally, we evaluate the results of grading function. For all $j \geq 0$ and the history $s_0 s_3$, we have that

$$G_\psi^a(s_0 s_3)(j) \triangleq \begin{cases} 1, & \text{if } j = 0; \\ 2, & \text{otherwise.} \end{cases}$$

For all $j \geq 0$ and $\rho \in s_0 \cdot (s_1 \cdot s_5)^+ \cdot s_8^+$, we have that

$$G_\psi^a(\rho)(j) \triangleq \omega$$

For all $\rho \in s_0 \cdot (s_1 \cdot s_5)^+ \cup s_0 \cdot (s_1 \cdot s_5)^* \cdot s_1 \cup \{s_0\}$, we have the same result of function f^* , i.e., $G_\psi^a(\rho)(j) \triangleq f^*(\rho)(j)$ for all $j \geq 0$.

6. Model Checking

We finally describe a solution of the model-checking problem for the fragment of $\text{GSL}[1G, 2AG]$, in which all temporal properties are used as in ATL . This means that we only admit *simple temporal properties*, *i.e.*, $\varphi_1 \mathbf{U} \varphi_2$, $\varphi_1 \mathbf{R} \varphi_2$, and $\mathbf{X}\varphi$, where φ_1 , φ_2 , and φ are sentences. This fragment, called Vanilla $\text{GSL}[1G, 2AG]$, is in relation with $\text{GSL}[1G, 2AG]$, as CTL and ATL are with CTL^* and ATL^* , respectively.

The idea here is to exploit the characterization of the grading function stated in Lemma 5.2 in order to verify whether a game structure \mathcal{G} satisfies a sentence $\varphi = \langle\langle \mathbf{x} \geq i \rangle\rangle [\langle\langle \bar{\mathbf{x}} \leq j \rangle\rangle (\alpha, \mathbf{x})(\bar{\alpha}, \bar{\mathbf{x}})\psi]$, while avoiding the naive calculation of the least fixpoint \mathbf{F}_ψ^α , which requires an infinite calculation due to the cycles of the structure.

Fortunately, due to the simplicity of the temporal property ψ , we have that the four sets \mathbf{W}_ψ , $\mathbf{W}_{\neg\psi}$, \mathbf{X} , and \mathbf{S} previously introduced are memoryless, *i.e.*, if a history belongs to them, every other history ending in the same state is also a member of these sets. Therefore, we can focus only on states by defining $\mathbf{W}_\psi \triangleq \{s \in \text{St} : \mathcal{G}, s \models \mathbf{A}\psi\}$, $\mathbf{W}_{\neg\psi} \triangleq \{s \in \text{St} : \mathcal{G}, s \models \mathbf{A}\neg\psi\}$, $\mathbf{X} \triangleq \text{St} \setminus (\mathbf{W}_\psi \cup \mathbf{W}_{\neg\psi})$, and $\mathbf{S} \triangleq \{s \in \text{St} : \mathcal{G}, s \models \mathbf{E}(\alpha \mathbf{U} \bar{\alpha} \neg\psi)\}$ via very simple CTL properties. Observe that we use α and $\bar{\alpha}$ as labeling of a state to recognize its owner. Intuitively, \mathbf{W}_ψ and $\mathbf{W}_{\neg\psi}$ contain the states from which agents α and $\bar{\alpha}$ can ensure, independently from the adversary, the properties ψ and $\neg\psi$, respectively. The set \mathbf{X} , instead, contains the states on which we have still to determine the number of strategies at disposal of the two agents. Finally, \mathbf{S} maintains the suicide states, *i.e.*, those states from which α can commit suicide by autonomously reaching $\mathbf{W}_{\neg\psi}$. In addition, since at most j strategies of $\bar{\alpha}$ can be avoided while reasoning on the sentence φ , we need just to deal with functions in the set $\Gamma \triangleq [0, j] \rightarrow (\mathbb{N} \cup \{\omega\})$ instead of $\Gamma \triangleq \mathbb{N} \rightarrow (\mathbb{N} \cup \{\omega\})$. Consequently, the functor $\mathbf{F}_\psi^\alpha : (\mathbf{X} \rightarrow \Gamma) \rightarrow (\mathbf{X} \rightarrow \Gamma)$ can be redefined as follows:

$$\mathbf{F}_\psi^\alpha(\mathbf{f})(s)(h) \triangleq \begin{cases} \sum_{s' \in \text{suc}(s) \cap \mathbf{X}} \mathbf{f}(s')(0) + |\text{suc}(s) \cap \mathbf{W}_\psi|, & \text{if } s \in \text{St}_\alpha \text{ and } h=0; \\ \sum_{s' \in \text{suc}(s) \cap \mathbf{X}} \mathbf{f}(s')(h), & \text{if } s \in \text{St}_\alpha \text{ and } h>0; \\ \sum_{\mathbf{c} \in \mathbf{C}(s)(h)} \prod_{s' \in \text{dom}(\mathbf{c})} \mathbf{f}(s')(\mathbf{c}(s')), & \text{otherwise;} \end{cases}$$

where $\text{suc}(s) = \{s' \in \text{St} : (s, s') \in \text{Ed}\}$ and $\mathbf{C}(s)(i) \subseteq (\text{suc}(s) \cap \mathbf{X}) \rightarrow \mathbb{N}$ contains all partial functions $\mathbf{c} \in \mathbf{C}(s)(i)$ for which α owns a suicide strategy on the states not in their domains, *i.e.*, $(\text{suc}(s) \cap \mathbf{X}) \setminus \text{dom}(\mathbf{c}) \subseteq \mathbf{S}$, and the sum of all values assumed by \mathbf{c} plus the number of successors that are neither surely winning nor contained in the domain of \mathbf{c} equals to i , *i.e.*, $i = \sum_{s' \in \text{dom}(\mathbf{c})} \mathbf{c}(s') + |\text{suc}(s) \setminus (\mathbf{W}_\psi \cup \text{dom}(\mathbf{c}))|$. Similarly, the grading function $\mathbf{G}_\psi^\alpha : \mathbf{X} \rightarrow \Gamma$ becomes

$$\mathbf{G}_\psi^\alpha(s)(h) \triangleq \sum_{l=0}^h \mathbf{f}^*(s)(l) + \begin{cases} 1, & \text{if } s \in \mathbf{S} \text{ and } h \geq 1; \\ 0, & \text{otherwise.} \end{cases}$$

where \mathbf{f}^* is the least fixpoint of \mathbf{F}_ψ^α . Observe that the existence of such a fixpoint can be proved in the same way of Lemma 5.1, where the set of functions \mathbf{D} is

$D \triangleq X \rightarrow \Gamma$, where $\Gamma \triangleq [0, j] \rightarrow (\mathbb{N} \cup \{\omega\})$. Unfortunately, these redefinitions are not enough by their own to ensure that the fixpoint calculation can be done in a finite, possibly small, number of iterations of the functor. This is due to two concomitant factors: the functions in Γ have an infinite codomain and the game structure \mathcal{G} might have cycles inside. In order to solve such a problem, we make use of the following observation. Suppose that agent α has at least one strategy on one of its states $s \in \text{St}_\alpha$ against all strategies of its opponent $\bar{\alpha}$ that is also part of a cycle in which no state of $\bar{\alpha}$ is adjacent to a state belonging to the set $W_{-\psi}$. Then, α can use this cycle from s to construct an infinite number of nonequivalent strategies, by simply pumping-up the number of times he decides to traverse it before following the previously found strategy. Therefore, in this case, we avoid to compute the infinite number of iterations required to reach the fixpoint, by directly assuming ω as value. Formally, we introduce the functor $l : (X \rightarrow \Gamma) \rightarrow (X \rightarrow \Gamma)$ defined as follows, where $L \subseteq \text{St}_\alpha$ denotes the set of α -states belonging to a cycle of the above kind: $l(f)(s)(h) = \omega$, if $s \in L$ and $f(s)(h) > 0$, and $l(f)(s)(h) = f(s)(h)$, otherwise, for all $s \in \text{St}$ and $h \in [0, j]$. It can be proved that $f^* = (l \circ F_\psi^\alpha)(f^*)$ iff $f^* = F_\psi^\alpha(f^*)$, *i.e.*, the functor obtained by composing l and F_ψ^α has exactly the same least fixpoint of F_ψ^α . Moreover, $f^* = (l \circ F_\psi^\alpha)^n(f_0)$ where $j \cdot |\mathcal{G}| \leq n$ and f_0 is the zero function, *i.e.*, $f_0(s)(h) = 0$, for all $s \in X$ and $h \in [0, j]$. Hence, we can compute f^* in a number of iterations of $l \circ F_\psi^\alpha$ that is linear in both the degree j and the size of \mathcal{G} . Finally, it is not hard to see that the computation of the sets L can be done in polynomial time.

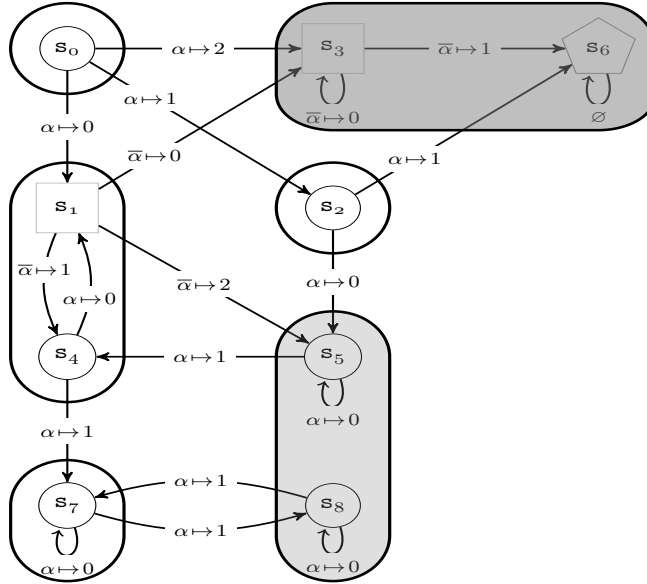

Figure 7: A two-player turn-based game structure.

As an example of an application of the model-checking procedure, consider the two-agent turn-based game structure \mathcal{G} depicted in Figure 7, with the

circle states ruled by α , the square ones by its opponent $\bar{\alpha}$, and where \mathbf{s}_5 and \mathbf{s}_8 are labeled by the atomic proposition \mathbf{p} . Also, consider the vanilla GSL[1G, 2AG] sentence $\varphi = \langle\langle \mathbf{x} \geq i \rangle\rangle [\bar{\mathbf{x}} \leq j] (\alpha, \mathbf{x})(\bar{\alpha}, \bar{\mathbf{x}}) \mathbf{Fp}$. First, we need to compute the preliminary sets of states $W_{\mathbf{Fp}} = \{\mathbf{s}_5, \mathbf{s}_8\}$ (the light-gray area), $W_{\neg \mathbf{Fp}} = \{\mathbf{s}_3, \mathbf{s}_6\}$ (the dark-gray area), $X = \{\mathbf{s}_0, \mathbf{s}_1, \mathbf{s}_2, \mathbf{s}_4, \mathbf{s}_7\}$ (the white area partitioned into strong-connected components), $S = \{\mathbf{s}_0, \mathbf{s}_2\}$, and $L = \{\mathbf{s}_7\}$. Now, we can evaluate the fixpoint \mathbf{f}^* of the functor $\mathbf{l} \circ \mathbf{F}_{\psi}^{\alpha}$ that can be obtained, due to the topology of \mathcal{G} , after $2(j+1)$ iterations, *i.e.*, $\mathbf{f}^* = (\mathbf{l} \circ \mathbf{F}_{\psi}^{\alpha})^{2(j+1)}(\mathbf{f}_0)$. Indeed, at the first one, the values on the states \mathbf{s}_2 and \mathbf{s}_7 are stabilized to $\mathbf{f}^*(\mathbf{s}_2)(0) = 1$, $\mathbf{f}^*(\mathbf{s}_7)(0) = \omega$, and $\mathbf{f}^*(\mathbf{s}_2)(h) = \mathbf{f}^*(\mathbf{s}_7)(h) = 0$, for all $h \in [1, j]$. After $2j$ iterations, we obtain $\mathbf{f}^*(\mathbf{s}_1)(0) = 0$, $\mathbf{f}^*(\mathbf{s}_1)(h) = \omega$, for all $h \in [1, j]$, and $\mathbf{f}^*(\mathbf{s}_4)(h) = \omega$, for all $h \in [0, j]$. By computing the last iteration, we derive $\mathbf{f}^*(\mathbf{s}_0)(0) = 1$ and $\mathbf{f}^*(\mathbf{s}_0)(h) = \omega$, for all $h \in [1, j]$. Note that $2(j+1)$ is exactly the sum $1 + 2j + 1$ of iterations that the components of the longest chain $\{\mathbf{s}_7\} < \{\mathbf{s}_1, \mathbf{s}_4\} < \{\mathbf{s}_0\}$ need in order to stabilize the values on their states. Finally, we can verify whether $\mathcal{G} \models \varphi$, by computing the grading function $\mathbf{G}_{\mathbf{Fp}}^{\alpha}$ at s_0 , whose values are $\mathbf{G}_{\mathbf{Fp}}^{\alpha}(s_0)(0) = 1$ and $\mathbf{G}_{\mathbf{Fp}}^{\alpha}(s_0)(h) = \omega$, for all $h \in [1, j]$. Thus, $\mathcal{G} \models \varphi$ iff $i = 1$ or $j > 0$.

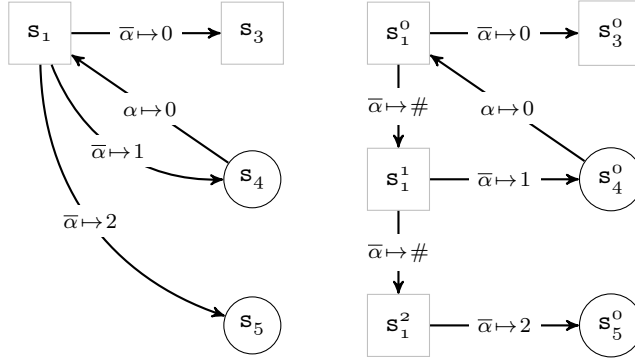

Figure 8: Degree transformation.

In order to obtain a PTIME procedure, we have also to ensure that each evaluation of the composed functor $\mathbf{l} \circ \mathbf{F}_{\psi}^{\alpha}$ can be computed in PTIME *w.r.t.* the above mentioned parameters. Actually, the whole \mathbf{l} and the first two items of $\mathbf{F}_{\psi}^{\alpha}$ can easily be calculated in linear time. The third item, instead, may require a sum of an exponential number of elements. Indeed, due to all possible ways a degree j can split among the successors of a state s , the corresponding set $C(s)(j)$ may contain an exponential number of functions. To avoid this, by exploiting a technique similar to the one proposed in [28, 16], we linearly transform a game structure into an equivalent one where all states ruled by $\bar{\alpha}$ have degree at most 2. Formally, starting from the CGS $\mathcal{G} \triangleq \langle \mathbf{AP}, \mathbf{Ag}, \mathbf{Ac}, \mathbf{St}, \mathbf{tr}, \mathbf{ap}, s_I \rangle$, we construct the equivalent $\mathcal{G}' \triangleq \langle \mathbf{AP}', \mathbf{Ag}, \mathbf{Ac}, \mathbf{St}', \mathbf{tr}', \mathbf{ap}', s_I \rangle$. The set of states is defined as follows: $\mathbf{St}' \triangleq \mathbf{St}_{\alpha} \cup \mathbf{St}_{\bar{\alpha}}$ with $\mathbf{St}_{\alpha} = \{s^0 \mid s \in \mathbf{St} \wedge \mathbf{own}(s) = \alpha\}$ and $\mathbf{St}_{\bar{\alpha}} = \{s^i \mid s \in \mathbf{St} \wedge 0 \leq i < |\mathbf{suc}(s)| \wedge \mathbf{own}(s) = \bar{\alpha}\}$, where $s^0, s^1, \dots, s^{|\mathbf{suc}(s)|-1}$ are

fresh states representing $|\text{suc}(s)|$ different copies of state s . The labeling function is so defined: $\text{ap}'(s^0) = \text{ap}(s)$ and $\text{ap}'(s^i) = \{\#\}$, for each $0 \leq i < |\text{suc}(s)|$. Let $\text{en} : \text{St} \times \text{Dc} \rightarrow [0, |\text{suc}(s) - 1|]$ be a partial function that returns the index of the decision such that it is injective and $\text{dom}(\text{en}) = \{(s, \delta) \mid \delta \in \text{dc}(s)\}$, we define $\text{dc}'(s^i) \triangleq \{\bar{\alpha} \rightarrow \#\} \cup \{\delta\}$ if $i \in [0, |\text{suc}(s)|]$ and $\text{en}(s, \delta) = i$, while $\text{dc}'(s^i) \triangleq \delta$ if $i = |\text{suc}(s) - 1|$ and $\text{en}(s, \delta) = i$. At this point, we can define the transition function as follows:

$$\text{tr}'(\delta)(s^i) \triangleq \begin{cases} s^{i+1}, & \text{if } s^i \in \text{St}_{\bar{\alpha}} \text{ and } \delta_{\bar{\alpha}} = \#; \\ t^0, & \text{otherwise, where } t = \text{tr}(\delta)(s). \end{cases}$$

In this way, the cardinality of $C(s)(j)$ is bounded by j . For example, consider the left part of Figure 8 representing the substructure of the previous game structure \mathcal{G} induced by the state s_1 together with its three successors. It is not hard to see that we can replace it, in \mathcal{G} , by the binary graph at its right, without changing the number of strategies that the two agents have at their disposal.

Theorem 6.1 (Model Checking). *The model-checking problem for Vanilla GSL[1G, 2AG] is PTIME in both the size of the game structure and the sentence. Moreover it is PTIME-HARD w.r.t. both the data and combined complexity.*

Proof. Suppose we want to verify that the vanilla GSL[1G, 2AG] sentence $\varphi = \langle\langle x \geq i \rangle\rangle[\bar{x} \leq j](\alpha, x)(\bar{\alpha}, \bar{x})\psi$ holds on a binary CGS \mathcal{G} (the general case easily follows by induction on the syntactic structure of the sentence, as in the classic ATL model-checking approach, and by linearly transforming any CGS into a binary one). First observe that the computation of the sets of surely-winning states W_ψ , surely-losing states $W_{\neg\psi}$, undetermined states $X = \text{St} \setminus (W_\psi \cup W_{\neg\psi})$, and suicide states S can be computed in linear time, since they are defined by means of simple CTL properties. Moreover, let $Z \subseteq \text{St}_{\bar{\alpha}}$ be the set of $\bar{\alpha}$ -states adjacent to some surely-losing state, and $L \subseteq \text{St}_\alpha$ the set of α -states of all cycles whose nodes do not belong to Z . Note that the elements of Z can be determined in linear time *w.r.t.* the number of moves of the CGS \mathcal{G} . Similarly, the sets L can be computed by applying the classic cycle-detection procedure based on DFS on the graph induced by the nodes in $\text{St} \setminus Z$. At this point, we can compute the least fixpoint f^* of the functor $l \circ F_\psi^\alpha$ in a number of steps that is bounded by the product of j with the number of moves in \mathcal{G} , where every step only requires polynomial time. As we show later, f^* is the least fixpoint for F_ψ^α as well. Therefore, the grading function G_ψ^α is immediately derived. Finally, $\mathcal{G} \models \varphi$ iff the conditions stated in Lemma 5.2 hold.

For the lower bound, observe that the PTIME hardness *w.r.t.* the size of the game is derived from the fact that classic reachability games [42] are subsumed. Instead, the hardness *w.r.t.* the combined complexity follows as GSL[1G, 2AG] subsumes CTL [43].

It remains to verify that the least fixpoint f^* of F_ψ^α is exactly the least fixpoint of $l \circ F_\psi^\alpha$, which can be computed in polynomial time. Since $F_\psi^\alpha(f^*) = f^*$, to prove that $(l \circ F_\psi^\alpha)(f^*) = f^*$, it is enough to show that $l(f^*) = f^*$. Indeed,

$(l \circ F_\psi^\alpha)(f^*) = l(F_\psi^\alpha(f^*)) = l(f^*)$. Now, let $s \in X$ and $h \in [0, h]$. By definition of the functor l , we have that, if $s \notin L$, then $l(f^*)(s)(h) = f^*(s)(h)$, else either $l(f^*)(s)(h) = \omega$ and $f^*(s)(h) > 0$ or $l(f^*)(s)(h) = f^*(s)(h) = 0$. Therefore, we have only to show that, if $f^*(s)(h) > 0$, then $f^*(s)(h) = \omega$, where $s \in L$. Since $s \in L$, there exists a cycle $s = s_0, s_1, \dots, s_n = s$, where all nodes do not belong to Z_h . In particular, by induction on the length n , we can show that there necessarily exists an index $i \in [0, n[$ such that $s_i \in \text{St}_\alpha$ has a successor s' different from s_{i+1} , where $f^*(s')(h) > 0$. Otherwise, we would have the existence of a fixpoint $f^{*'}$ for the functor F_ψ^α , where $f^{*'}(s_i)(h) = 0$, which contradicts the fact that f^* is the least fixpoint of F_ψ^α . Moreover, by direct inspection of the definition of F_ψ^α , we have that $f^*(s)(h) = f^*(s_0)(h) \geq f^*(s_1)(h) \geq \dots \geq f^*(s_i)(h) \geq f^*(s')(h) + f^*(s_{i+1})(h) \geq f^*(s')(h) + f^*(s_{i+2})(h) \geq \dots \geq f^*(s')(h) + f^*(s_n)(h) = f^*(s')(h) + f^*(s)(h)$, *i.e.*, $f^*(s)(h) \geq f^*(s')(h) + f^*(s)(h) \geq 1 + f^*(s)(h)$. Hence, we necessarily have $f^*(s)(h) = \omega$.

Finally, to show that f^* can be computed in polynomial time, we prove that $f^* = (l \circ F_\psi^\alpha)^n(f_0)$, where $n = j \cdot |\mathcal{G}|$ and f_0 is the zero function, *i.e.*, $f_0(s)(h) = 0$, for all $s \in X$ and $h \in [0, j]$. Let $f^i = (l \circ F_\psi^\alpha)^i(f_0)$, for $i \in]0, n]$. It is easy to observe that $f^i(s)(0) = 0$, for all states $s \in Z$ and indexes $i \in [0, n]$. This is due to the fact that the set of functions $C(s)(0)$ used in the definition of F_ψ^α is necessarily empty. Therefore, after $|\mathcal{G}|$ iterations, we have that all values of $f^*(s)(0)$ are determined. Indeed, all cycles passing through Z cannot pump up the values of the corresponding nodes, while those avoiding Z , thanks to the functor l , immediately reach the value ω as soon as they are positive. The same reasoning applies, in general, for the computation of the values $f^*(s)(h)$ that are determined after at most $h|\mathcal{G}|$ iterations, since they only depend on the values $f^*(s')(h')$, where $h' \leq h$. \square

7. Discussion

In multi-agent systems general questions to be investigated are: “*is there a winning strategy?*” or “*is the game surely winning?*” (*i.e.*, no matter which strategy the agent can play). In the years, several logics suitable for the strategic reasoning have been introduced and, by means of existential and universal modalities, this kind of questions has been addressed [13]. However, these logics are not able to address quantitative aspects such as “*what is the number of winning strategies an agent can play?*” or, in general, to determine the *success rate of a game* [17]. These questions are critical in dealing with solution concepts [44] and in open-system verification [30].

In this paper, we have introduced and studied GSL, an extension of Strategy Logic with graded modalities. The use of a powerful formalism such as Strategy Logic ensures the ability of dealing with very intricate game scenarios [15]. The obvious drawback of this is a considerable amount of work on solving any related question [32]. One of the main difficulties we have faced in GSL has been the definition of the right methodology to count strategies. To this aim, we have introduced a suitable equivalence relation over strategy profiles based on the

strategic behavior they induce and studied its robustness. Also, we have provided arguments and some examples along the paper to give evidence of the usefulness of GSL and the suitability of the proposed counting.

In order to provide results of practical use, we have investigated basic questions over a restricted fragment of GSL. Precisely we have considered the case in which the graded modalities are applied to the *vanilla* restriction of the one-goal fragment of SL [32]. The resulting logic, named *Vanilla* SL[1G], has been investigated in the turn-based setting. We have obtained positive results about determinacy and showed that the related model-checking problem is PTIME-COMPLETE.

The framework and the results presented in this paper open for several future work questions. First, it would be worth investigating the extension of existing formal verification tools such as MCMAS [45] with our results. We recall that MCMAS, originally developed for the verification for multi-agent models with respect to specification given in ATL [45], has been recently extended to handle Strategy Logic specifications [46, 47]. Under our formalism it is possible to check, in a single evaluation process, that more than one strategy gives a fault and possibly correct all these errors. This in a way similar as the verification tool NuSMV has been extended to deal with *graded-CTL* verification [31].

Another research direction regards investigating the graded extension of other formalism for the strategic reasoning such as *ATL with context* [48, 49], as well as, for the sake of completeness, to determine the complexity of the model checking problem with respect to other fragments of Strategy Logic [50, 51].

Finally, it would be really interesting to address the satisfiability for GSL[1G] too, by generalizing the solution procedure developed for SL[1G] [32]. However, we want to observe that, the technical tools described in this article are not powerful enough to solve this problem, since this also needs a bounded-width tree model property. So, further work is still required. Moreover, the procedure exploited for graded CTL [27, 28, 16] cannot easily be applied to GSL[1G], due to the fact that the binary-tree unraveling used there would modify the way the strategies are valuated as equivalent.

References

- [1] E. Clarke, E. Emerson, Design and Synthesis of Synchronization Skeletons Using Branching-Time Temporal Logic., in: Logic of Programs'81, LNCS 131, Springer, 1981, pp. 52–71.
- [2] J. Queille, J. Sifakis, Specification and Verification of Concurrent Programs in Cesar., in: Symposium on Programming'81, LNCS 137, Springer, 1981, pp. 337–351.
- [3] A. Pnueli, The Temporal Logic of Programs., in: Foundation of Computer Science'77, IEEE Computer Society, 1977, pp. 46–57.
- [4] E. Emerson, J. Halpern, “Sometimes” and “Not Never” Revisited: On Branching Versus Linear Time., Journal of the ACM 33 (1) (1986) 151–178.

- [5] D. Harel, A. Pnueli, *On the Development of Reactive Systems.*, Springer, 1985.
- [6] E. Clarke, O. Grumberg, D. Peled, *Model Checking.*, MIT Press, 2002.
- [7] B. Bérard, M. Bidoit, A. Finkel, F. Laroussinie, A. Petit, L. Petrucci, P. Schnoebelen, *Systems and Software Verification: Model-Checking Techniques and Tools.*, Springer, 2010.
- [8] O. Kupferman, M. Vardi, Module checking, in: *CAV'96*, LNCS 1102, Springer, 1996, pp. 75–86.
- [9] O. Kupferman, M. Vardi, P. Wolper, *Module Checking.*, *Information and Computation* 164 (2) (2001) 322–344.
- [10] B. Aminof, A. Legay, A. Murano, O. Serre, M. Vardi, Pushdown Module Checking with Imperfect Information., *Information and Computation* 223 (2013) 1–17.
- [11] W. Jamroga, A. Murano, On Module Checking and Strategies., in: *AAMAS 14*, IFAAMAS, 2014, pp. 701–708.
- [12] W. Jamroga, A. Murano, Module Checking of Strategic Ability, in: *AAMAS 15*, IFAAMAS, 2015, pp. 227–235.
- [13] R. Alur, T. Henzinger, O. Kupferman, Alternating-Time Temporal Logic., *Journal of the ACM* 49 (5) (2002) 672–713.
- [14] K. Chatterjee, T. Henzinger, N. Piterman, Strategy Logic., in: *Concurrency Theory'07*, LNCS 4703, Springer, 2007, pp. 59–73.
- [15] F. Mogavero, A. Murano, M. Vardi, Reasoning About Strategies., in: *FSTTCS 10*, LIPIcs 8, Leibniz-Zentrum fuer Informatik, 2010, pp. 133–144.
- [16] A. Bianco, F. Mogavero, A. Murano, Graded Computation Tree Logic., *Transactions On Computational Logic* 13 (3) (2012) 25:1–53.
- [17] V. Malvone, A. Murano, L. Sorrentino, Games with Additional Winning Strategies, in: *CILC 2015*, CEUR, 2015, pp. 175–180.
- [18] K. Fine, In So Many Possible Worlds., *Notre Dame Journal of Formal Logic* 13 (1972) 516–520.
- [19] E. Grädel, M. Otto, E. Rosen, Two-Variable Logic with Counting is Decidable., in: *LICS 97*, IEEECS, 1997, pp. 306–317.
- [20] C. Lutz, U. Sattler, L. Tendera, The Complexity of Finite Model Reasoning in Description Logics, *Information and Computation* 199 (1) (2005) 132–171.
- [21] C. Lutz, D. Walther, F. Wolter, Conservative Extensions in Expressive Description Logics., in: *IJCAI*, Vol. 7, 2007, pp. 453–458.

- [22] D. Calvanese, G. D. Giacomo, M. Lenzerini, Reasoning in Expressive Description Logics with Fixpoints based on Automata on Infinite Trees, in: IJCAI, Vol. 99, 1999, pp. 84–89.
- [23] M. Arenas, P. Barceló, L. Libkin, Combining Temporal Logics for Querying XML Documents, in: Database Theory–ICDT 2007, Springer, 2007, pp. 359–373.
- [24] E. Bárcenas, A counting logic for trees, *Computación y Sistemas* 19 (2) (2015) 407–422.
- [25] O. Kupferman, U. Sattler, M. Vardi, The Complexity of the Graded mu-Calculus., in: CADE 02, LNCS 2392, Springer, 2002, pp. 423–437.
- [26] A. Ferrante, M. Napoli, M. Parente, Model Checking for Graded CTL., *Fundamenta Informaticae* 96 (3) (2009) 323–339.
- [27] A. Bianco, F. Mogavero, A. Murano, Graded Computation Tree Logic., in: LICS 09, IEEECS, 2009, pp. 342–351.
- [28] A. Bianco, F. Mogavero, A. Murano, Graded Computation Tree Logic with Binary Coding., in: Computer Science Logic’10, LNCS 6247, Springer, 2010, pp. 125–139.
- [29] B. Aminof, A. Murano, S. Rubin, On CTL* with Graded Path Modalities, in: LPAR-20 2015, LNCS 9450, Springer, 2015, pp. 281–296.
- [30] A. Ferrante, A. Murano, M. Parente, Enriched Mu-Calculi Module Checking., *Logical Methods in Computer Science* 4 (3) (2008) 1–21.
- [31] M. Faella, M. Napoli, M. Parente, Graded Alternating-Time Temporal Logic., *Fundamenta Informaticae* 105 (1-2) (2010) 189–210.
- [32] F. Mogavero, A. Murano, G. Perelli, M. Vardi, What Makes ATL* Decidable? A Decidable Fragment of Strategy Logic., in: CONCUR 12, LNCS 7454, Springer, 2012, pp. 193–208.
- [33] T. Antal, A. Traulsen, H. Ohtsuki, C. Tarnita, M. Nowak, Mutation-Selection Equilibrium in Games with Multiple Strategies., *Journal of Theoretical Biology* 258 (4) (2009) 614–622.
- [34] S. Kripke, Semantical Considerations on Modal Logic., *Acta Philosophica Fennica* 16 (1963) 83–94.
- [35] R. Keller, Formal Verification of Parallel Programs., *Communication of the ACM* 19 (7) (1976) 371–384.
- [36] F. Mogavero, A. Murano, G. Perelli, M. Vardi, Reasoning About Strategies: On the Model-Checking Problem., *Transactions On Computational Logic* 15 (4) (2014) 34:1–42.

- [37] F. Mogavero, A. Murano, L. Sauro, Strategy Games: A Renewed Framework., in: AAMAS 14, IFAAMAS, 2014, pp. 869–876.
- [38] A. Martin, Borel Determinacy., *Annals of Mathematics* 102 (2) (1975) 363–371.
- [39] D. Perrin, J. Pin, *Infinite Words.*, Pure and Applied Mathematics., Elsevier, 2004.
- [40] G. Winskel, *The Formal Semantics of Programming Languages (An Introduction).*, Foundation of Computing Series, MIT Press, 1993.
- [41] A. Martin, A Purely Inductive Proof of Borel Determinacy., in: SPM 82, Recursion Theory., AMS and ASL, 1985, pp. 303–308.
- [42] N. Immerman, Number of Quantifiers is Better Than Number of Tape Cells., *Journal of Computer and System Science* 22 (3) (1981) 384–406.
- [43] P. Schnoebelen, The Complexity of Temporal Logic Model Checking., in: AIML 02, CP, 2002, pp. 393–436.
- [44] R. Myerson, *Game Theory: Analysis of Conflict.*, Harvard University Press, 1991.
- [45] A. Lomuscio, F. Raimondi, MCMAS: A Model Checker for Multi-agent Systems., in: TACAS 06, LNCS 3920, Springer, 2006, pp. 450–454.
- [46] P. Čermák, A. Lomuscio, F. Mogavero, A. Murano, MCMAS-SLK: A Model Checker for the Verification of Strategy Logic Specifications., in: CAV 14, LNCS 8559, Springer, 2014, pp. 524–531.
- [47] P. Čermák, A. Lomuscio, A. Murano, Verifying and Synthesising Multi-Agent Systems against One-Goal Strategy Logic Specifications, in: AAAI’15, AAAI Press, 2015, pp. 2038–2044.
- [48] T. Brihaye, A. D. C. Lopes, F. Laroussinie, N. Markey, ATL with Strategy Contexts and Bounded Memory., in: LFCS 09, LNCS 5407, Springer, 2009, pp. 92–106.
- [49] A. Lopes, F. Laroussinie, N. Markey, ATL with Strategy Contexts: Expressiveness and Model Checking., in: FSTTCS 10, LIPIcs 8, Leibniz-Zentrum fuer Informatik, 2010, pp. 120–132.
- [50] F. Mogavero, A. Murano, L. Sorrentino, On Promptness in Parity Games., in: LPAR 13, LNCS 8312, Springer, 2013, pp. 601–618.
- [51] F. Mogavero, A. Murano, L. Sauro, A Behavioral Hierarchy of Strategy Logic., in: CLIMA 14, LNCS 8624, Springer, 2014, pp. 148–165.